

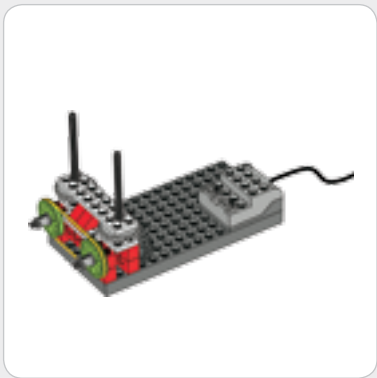

1

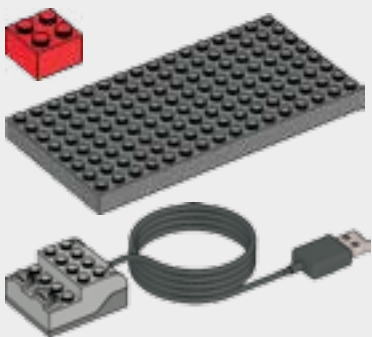

2

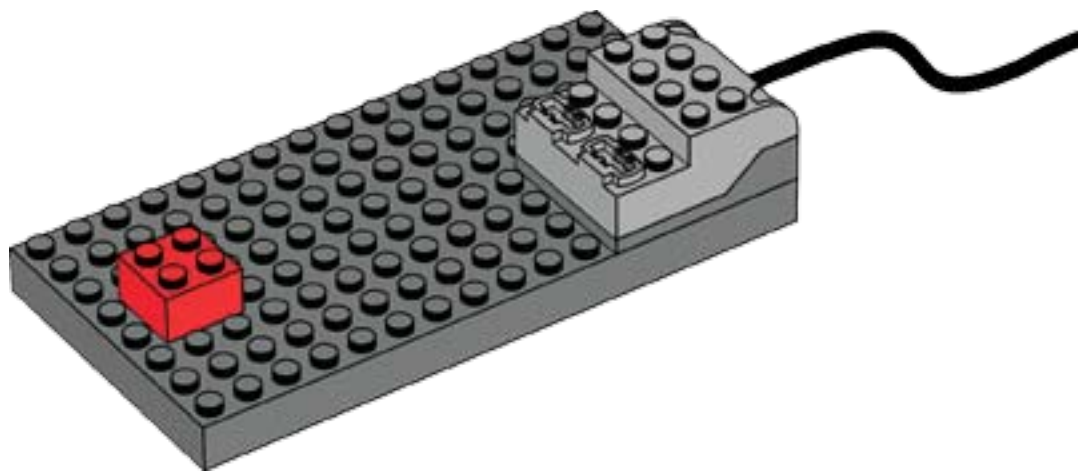
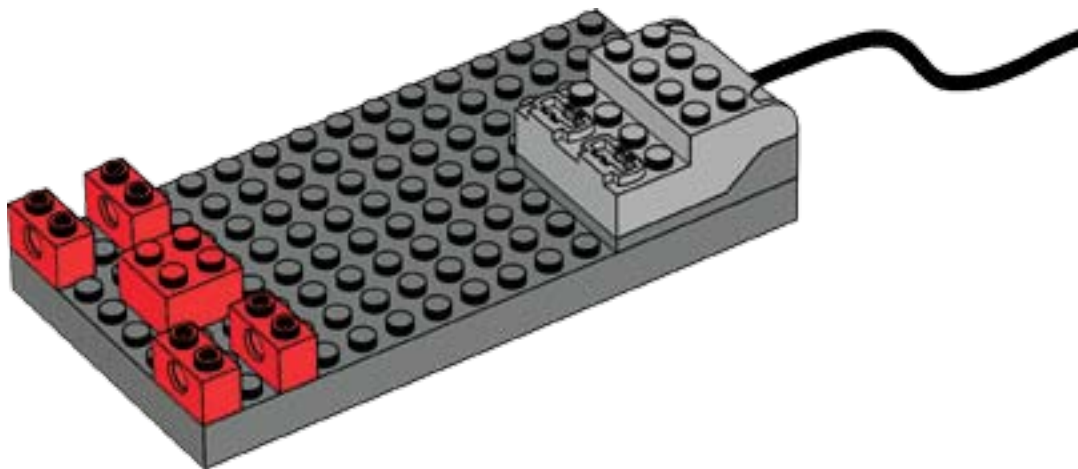

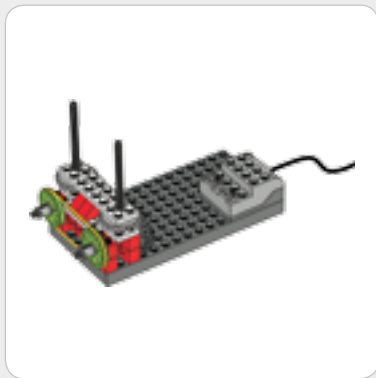

3

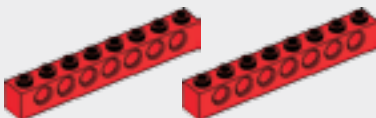
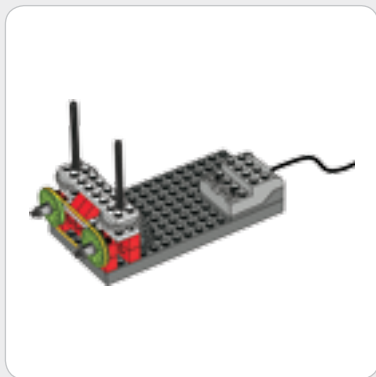
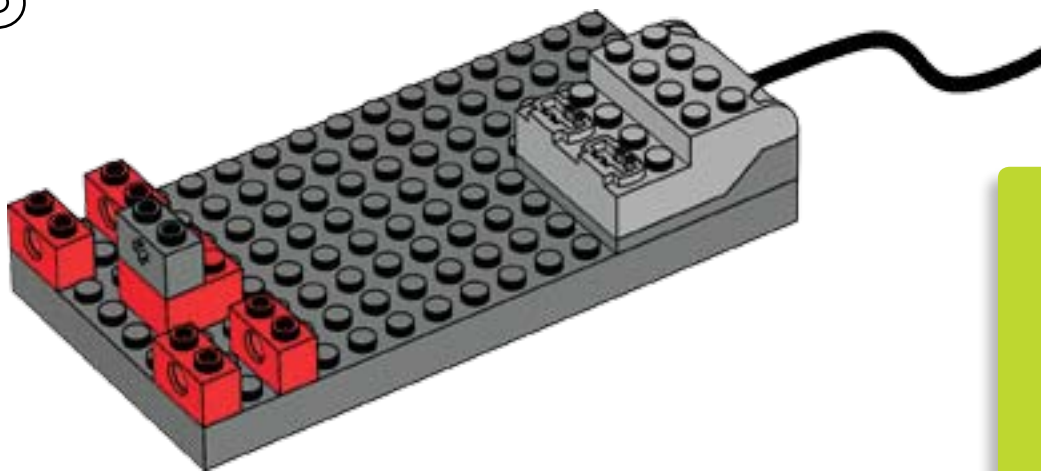

4

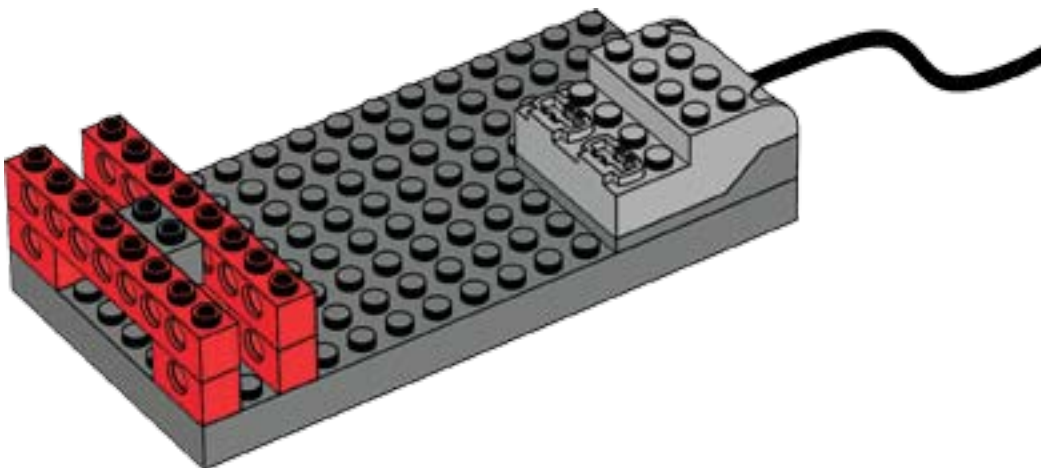

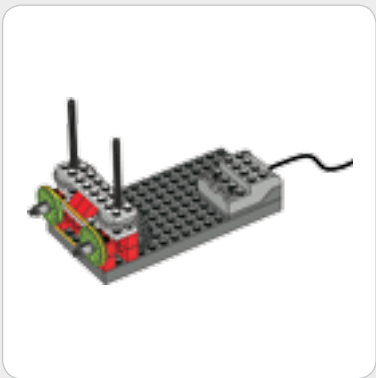

5

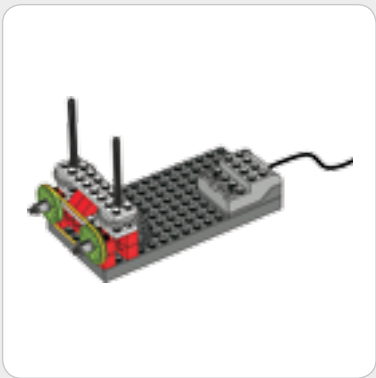
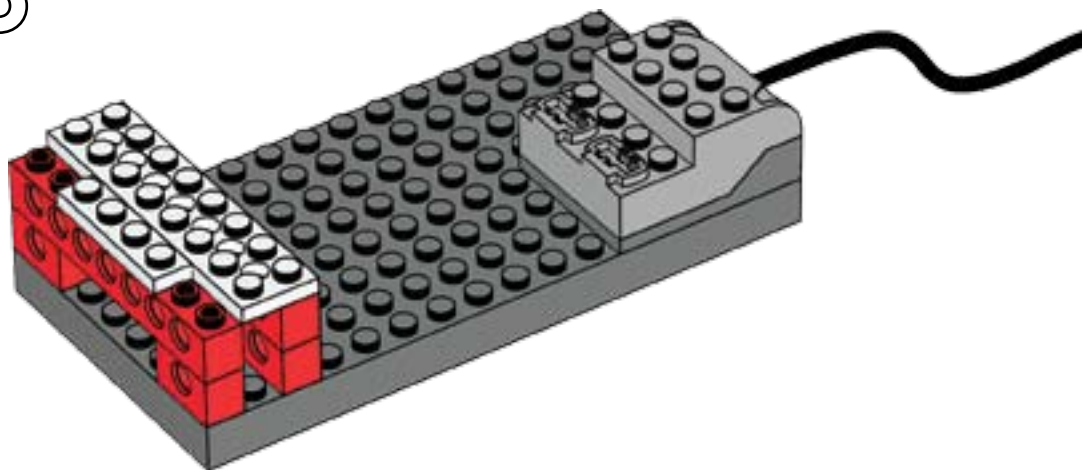

6

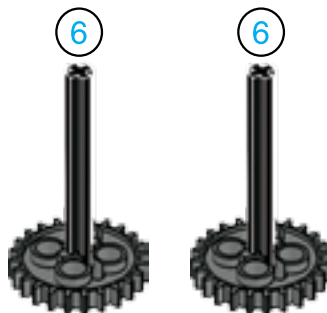

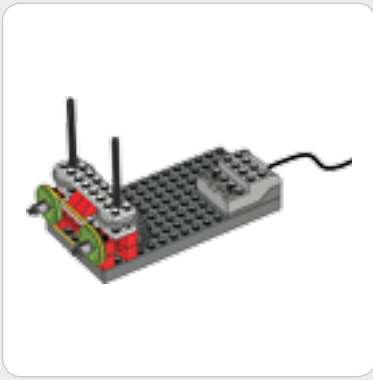

7

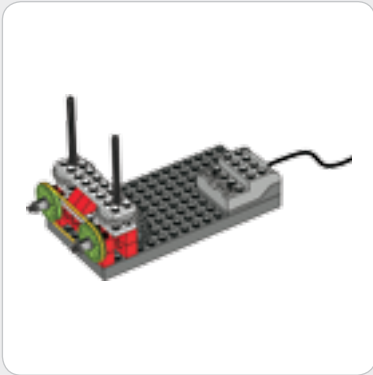
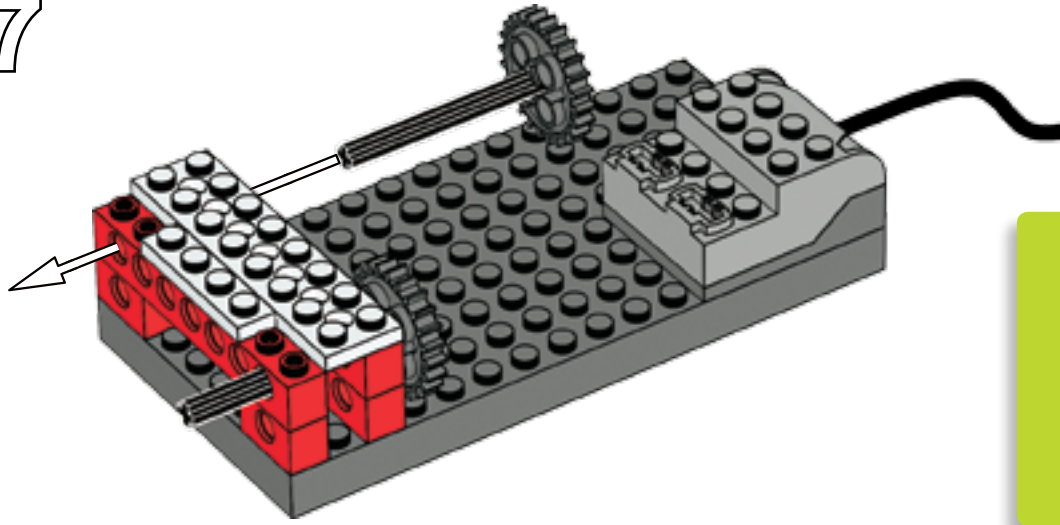

8

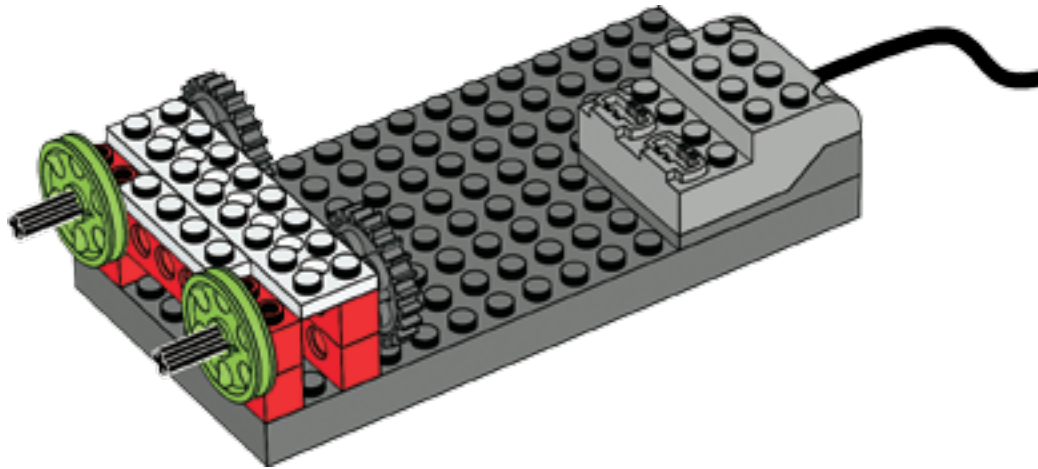

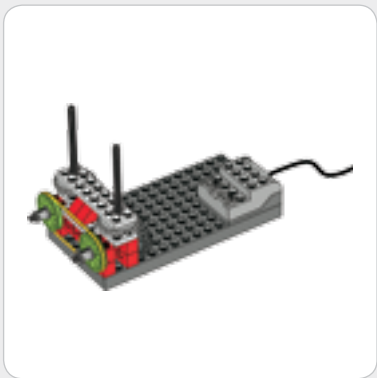

9

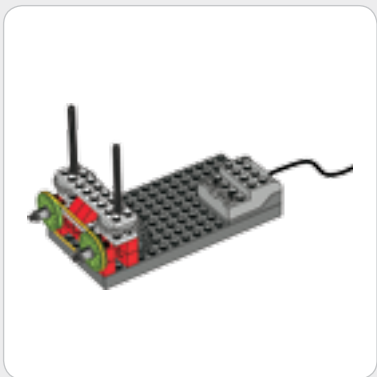
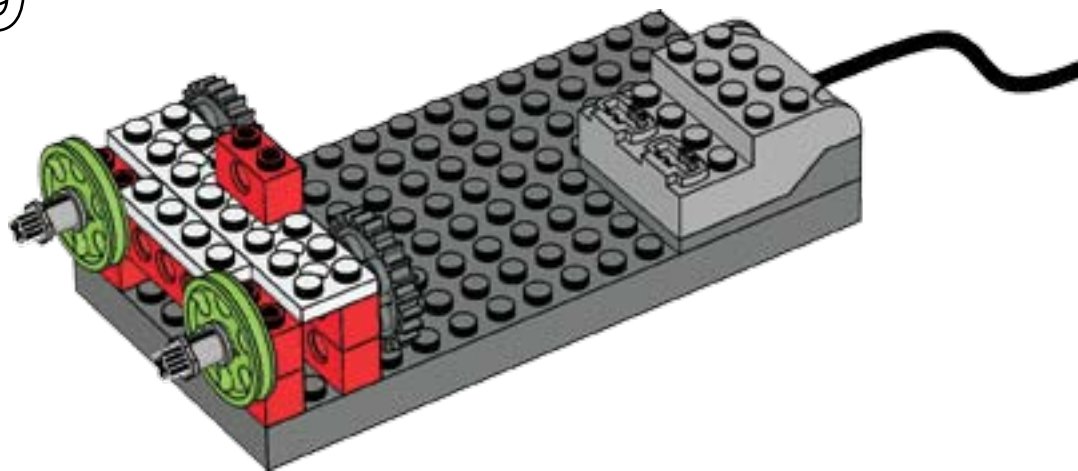

10

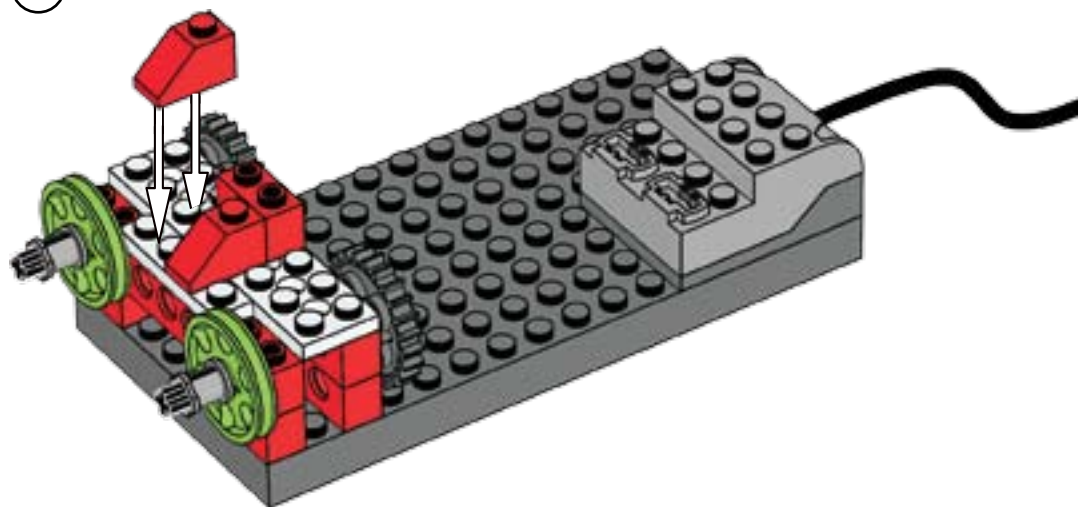



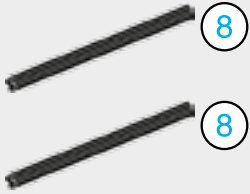

11

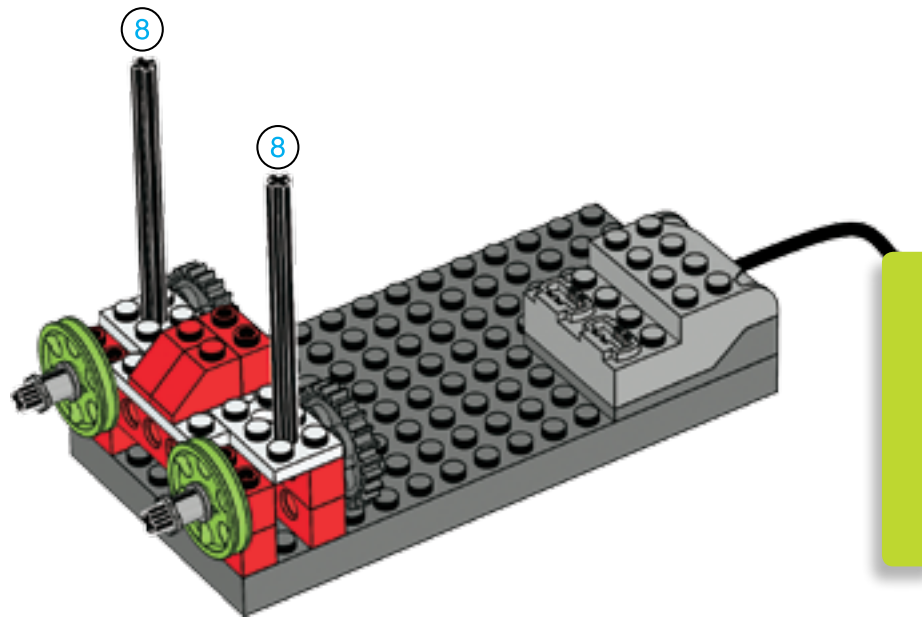

12

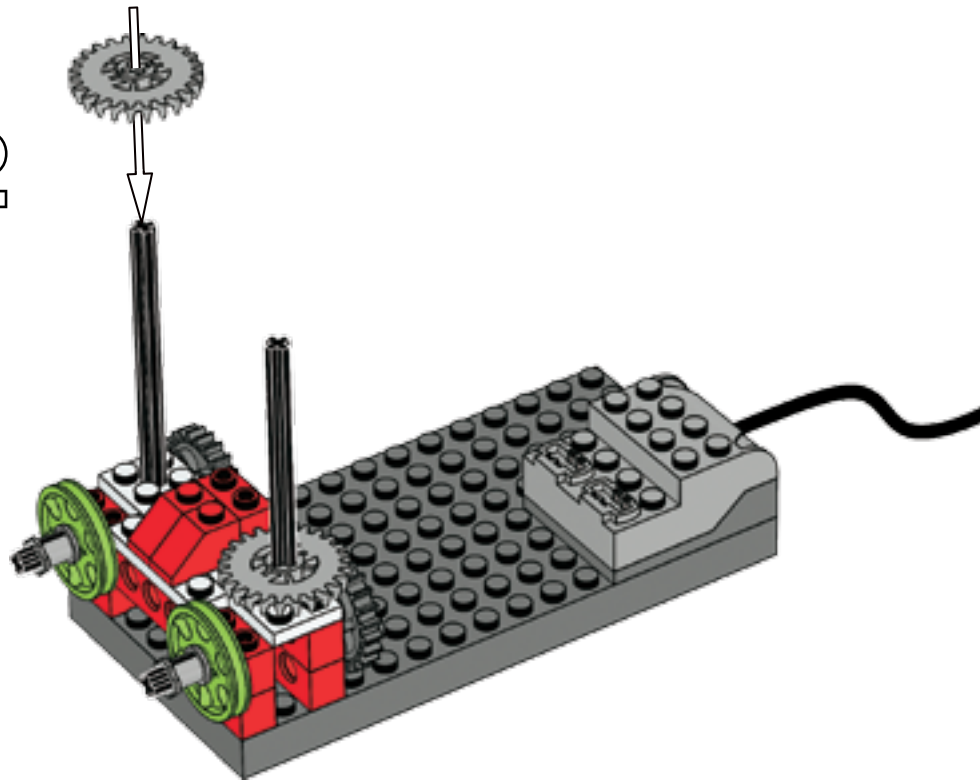

13

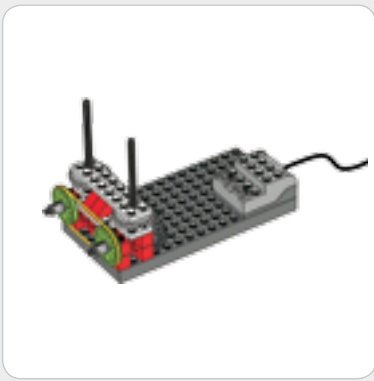
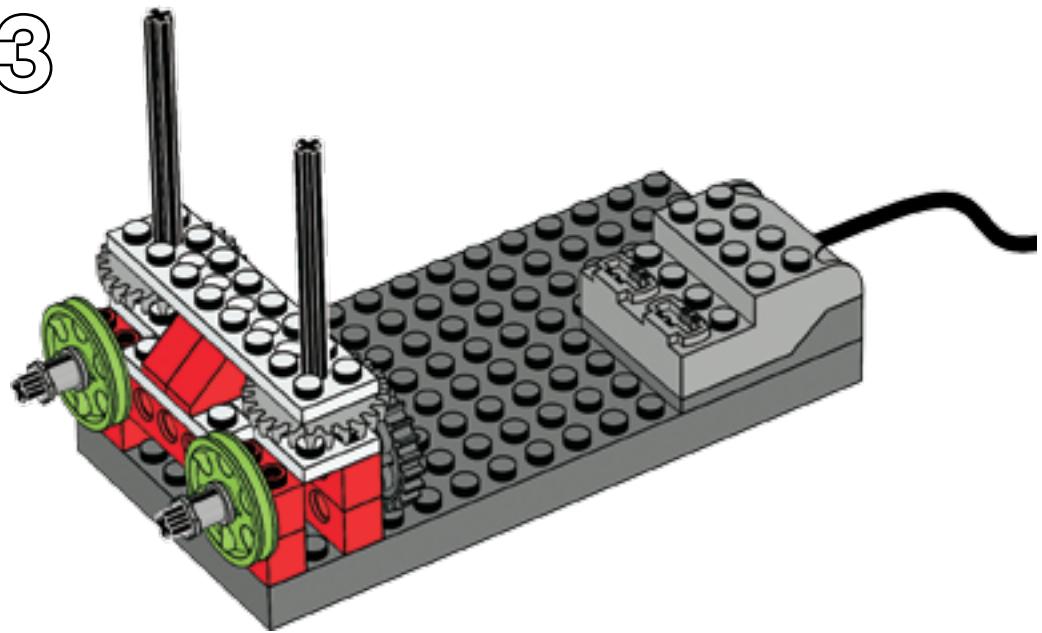

14

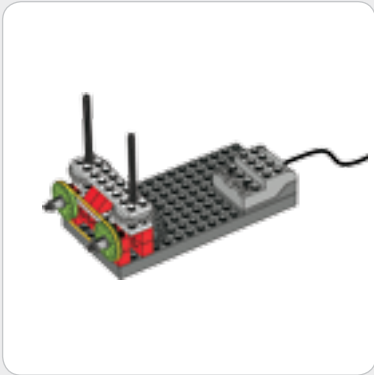
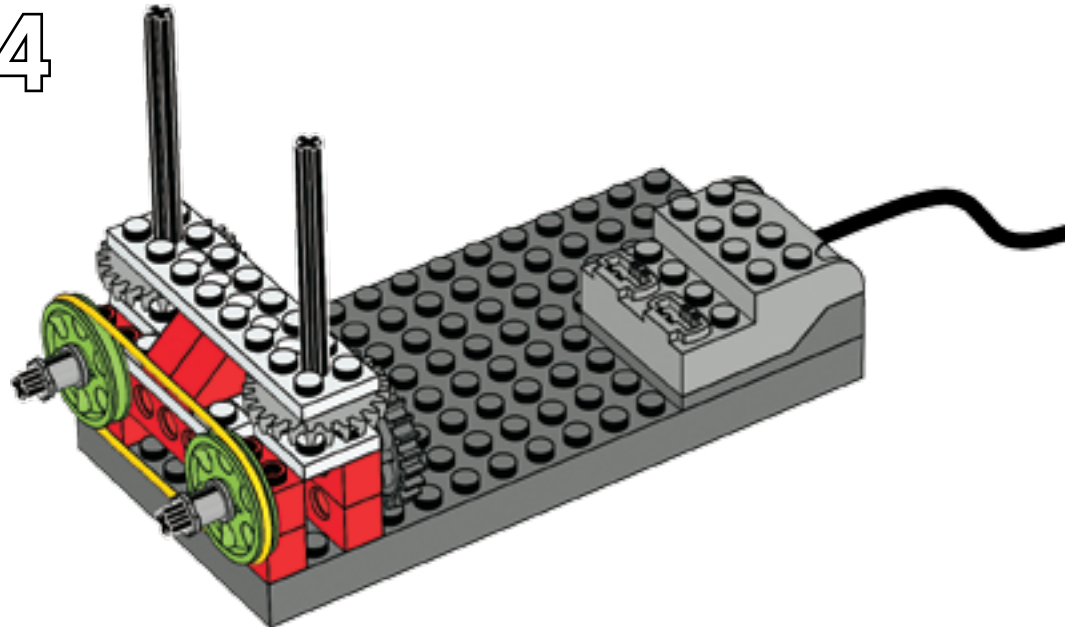



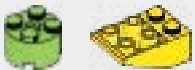
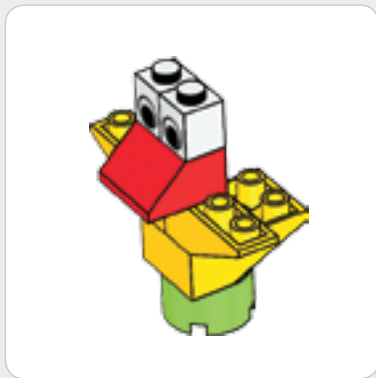

15

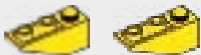
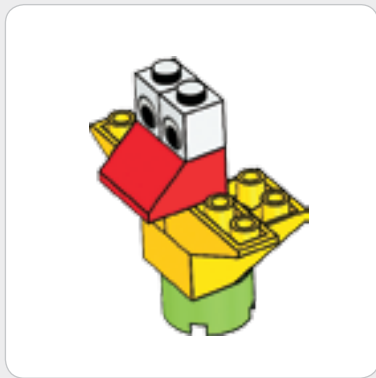

16

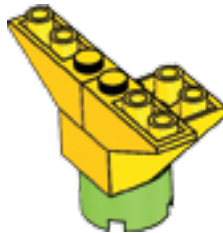

17

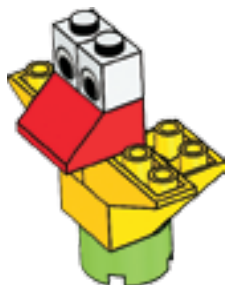
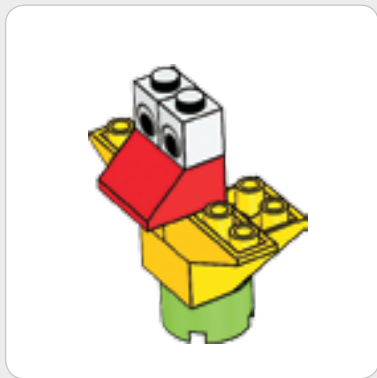

18

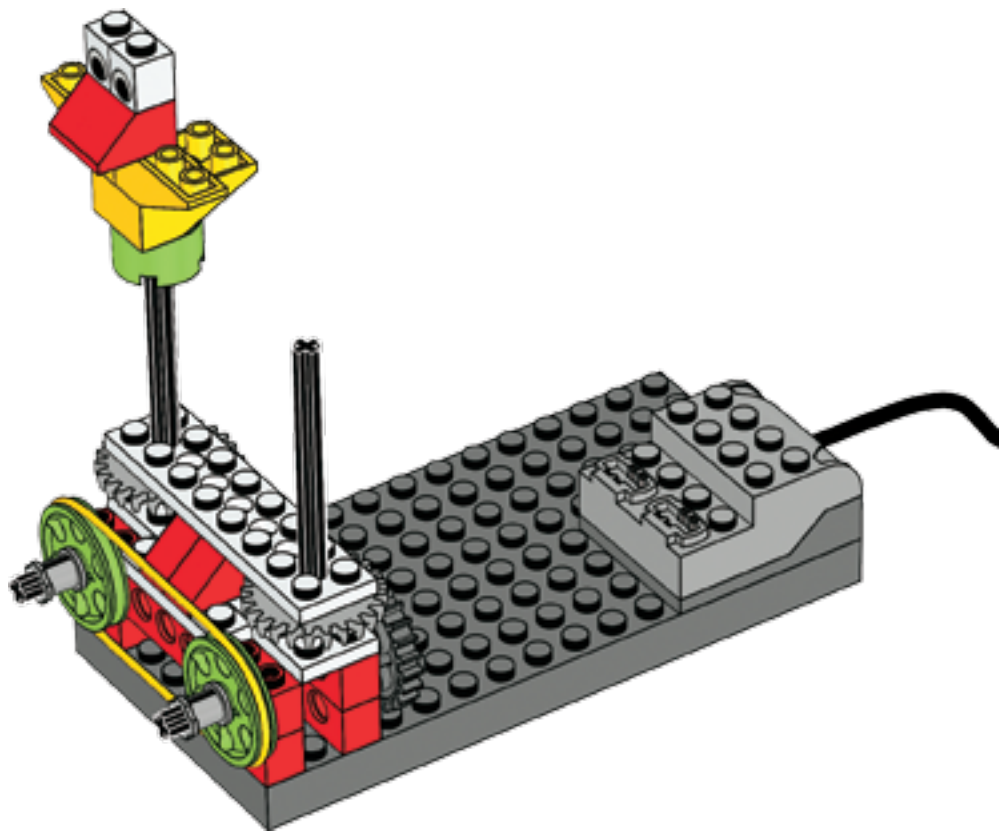

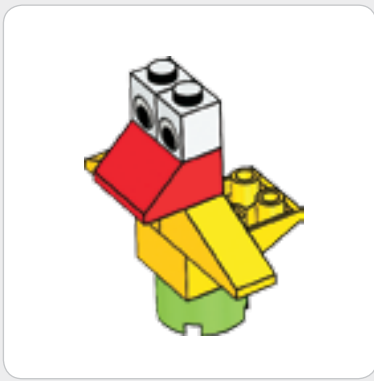

19

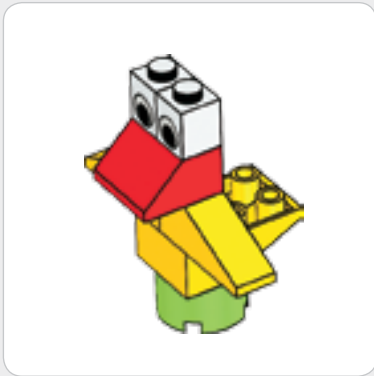

20



21

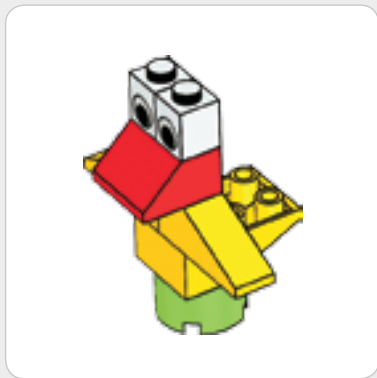

22

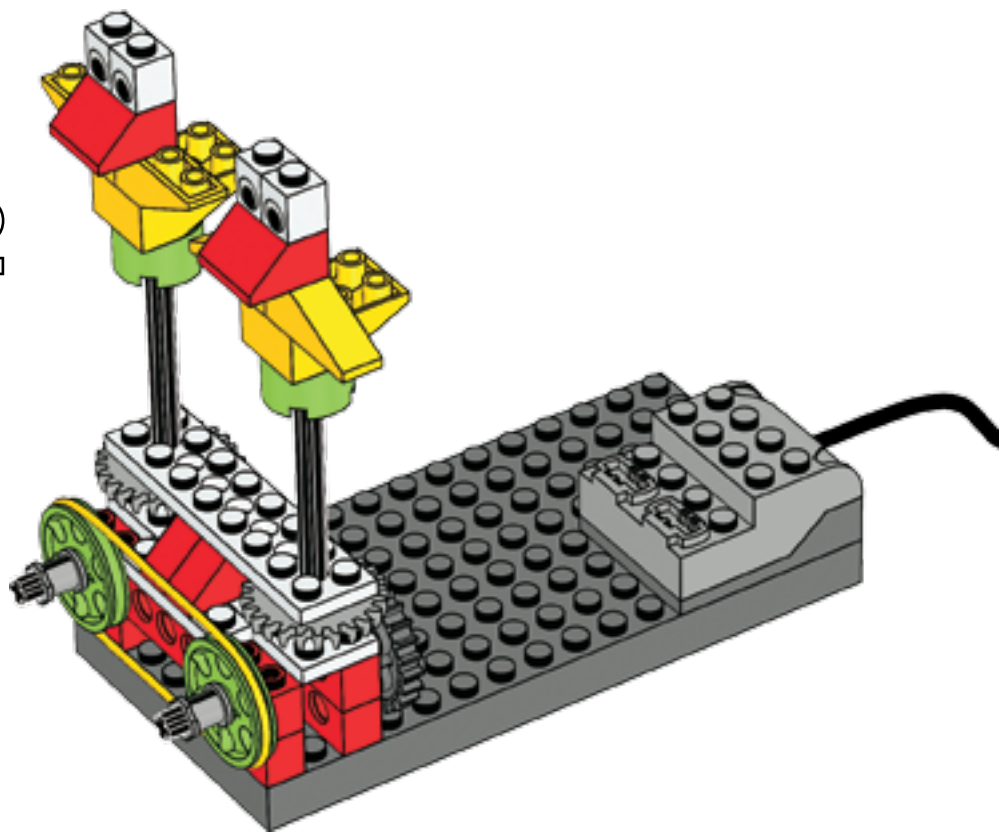

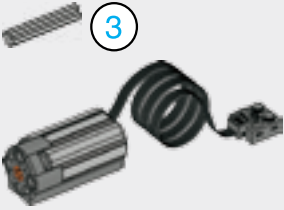

23

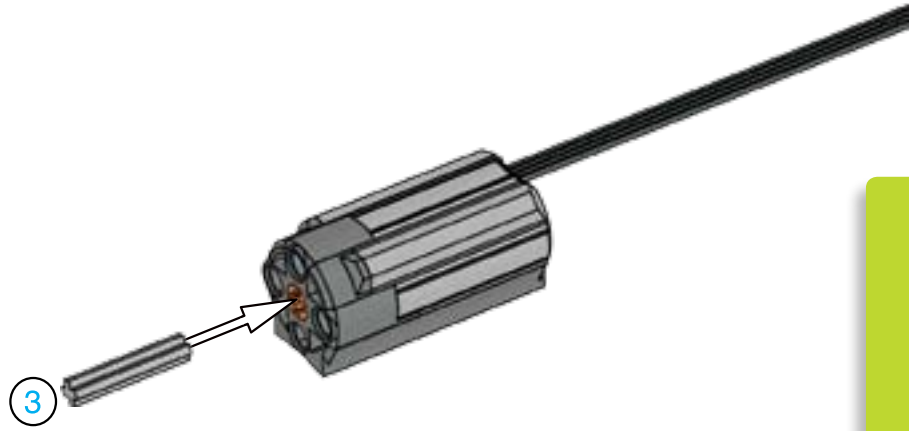

24

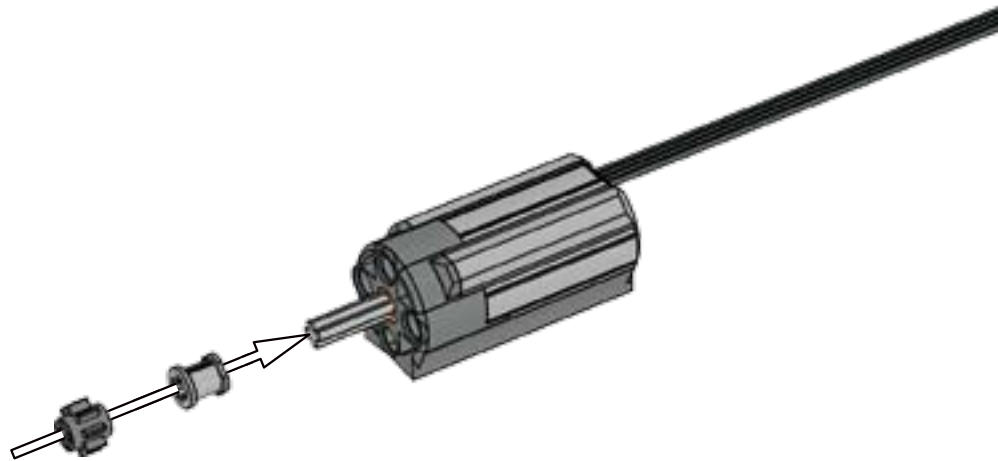





25

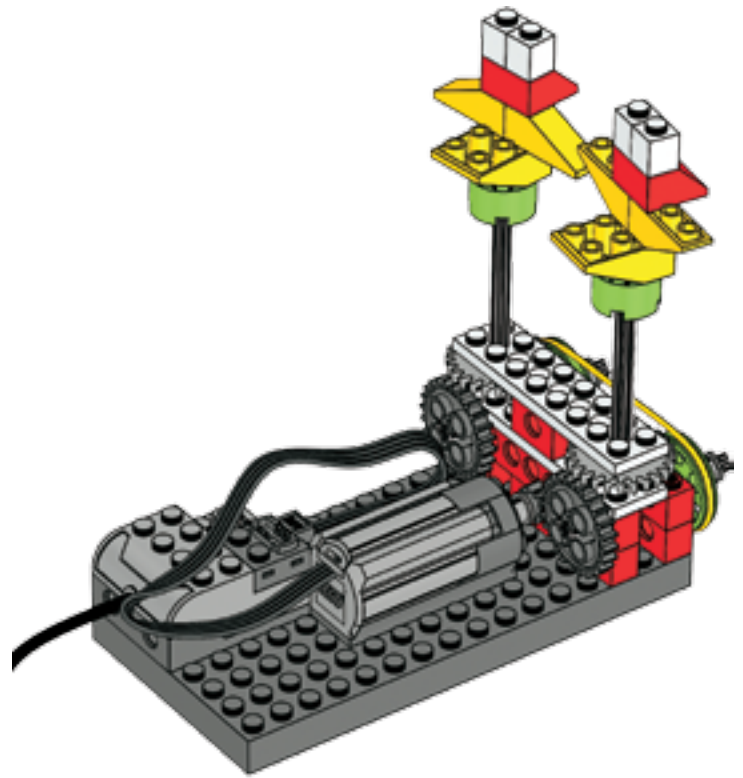

26

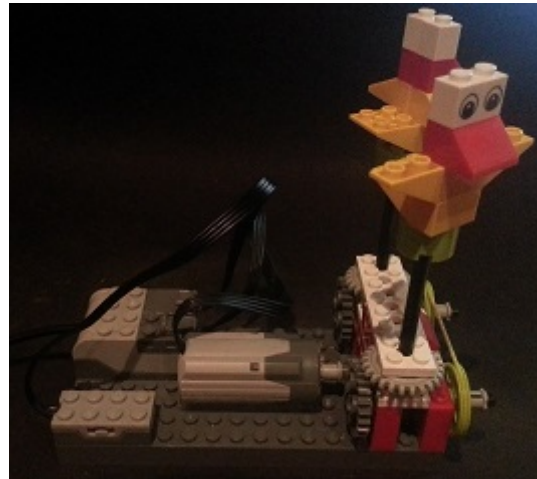

# Programación Robot

1



2



3



4

