

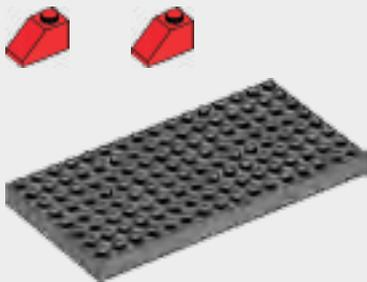



1



2





3

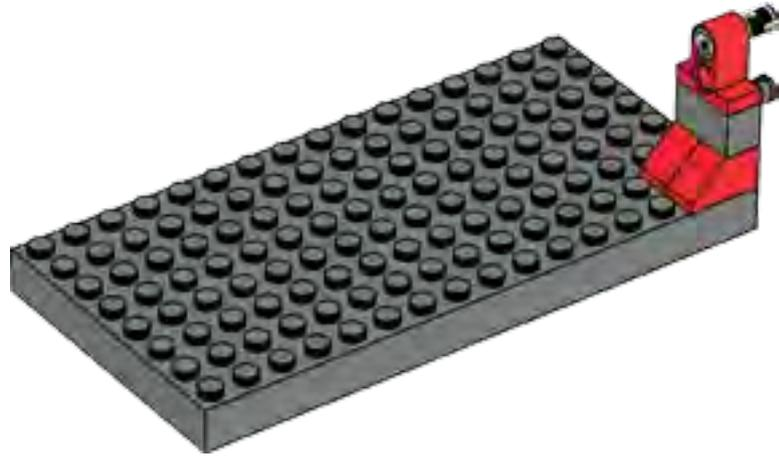

4

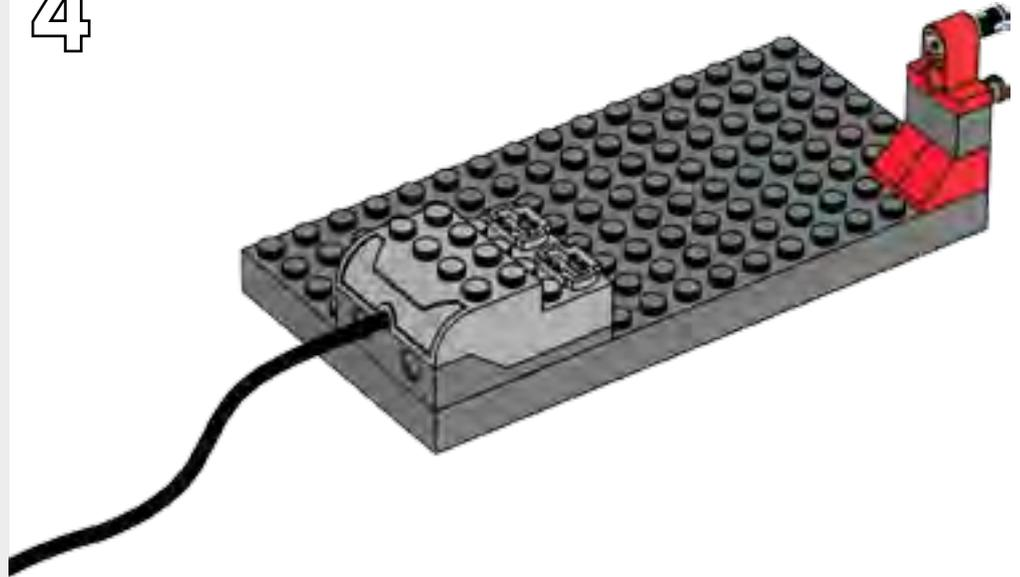



5

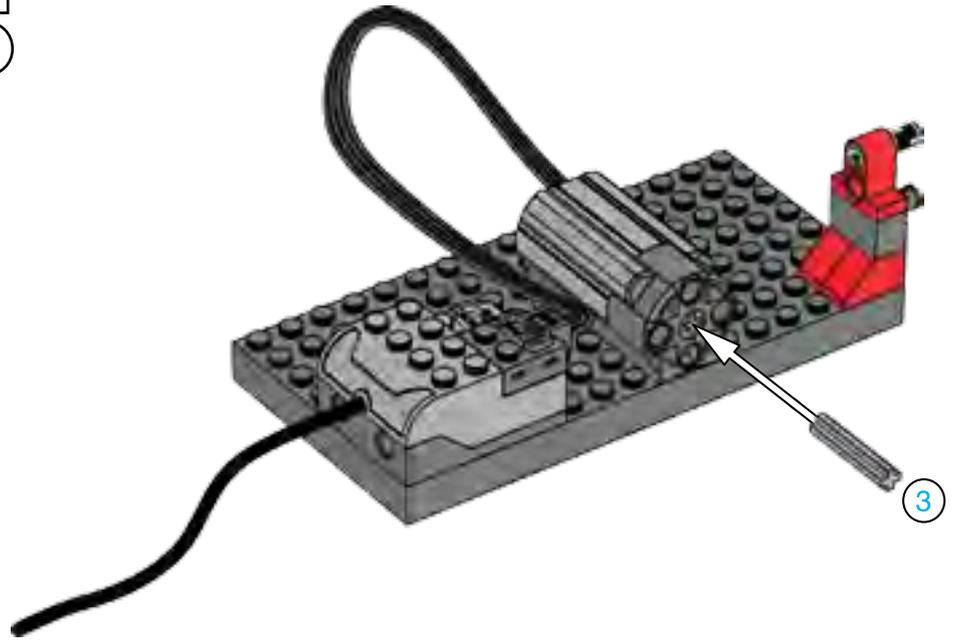

6





7

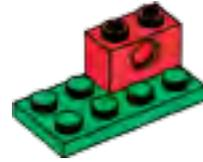

8

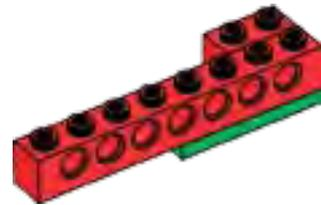



9

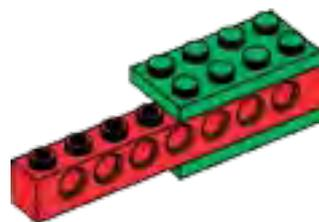

10

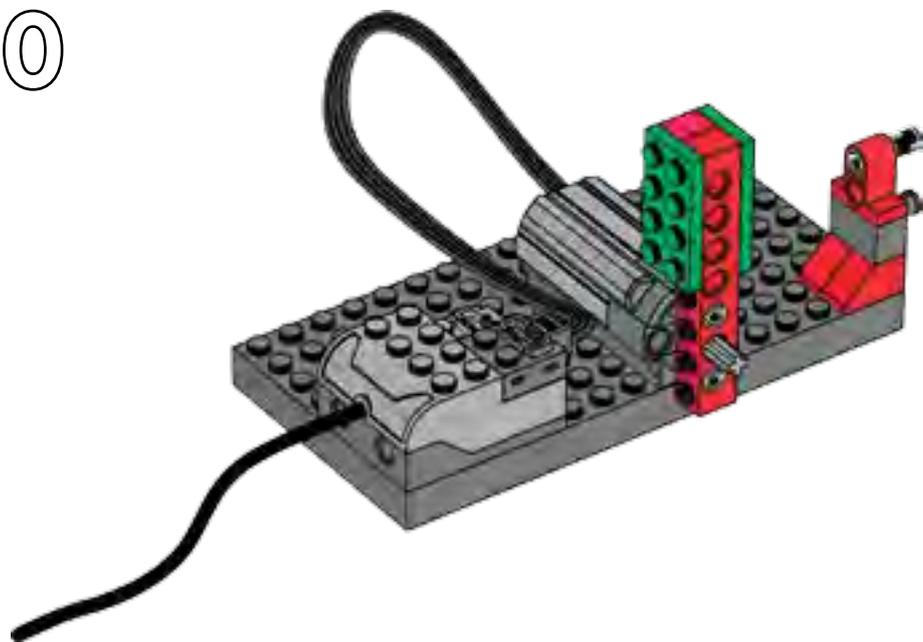



11

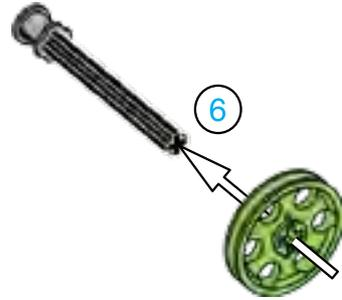

12

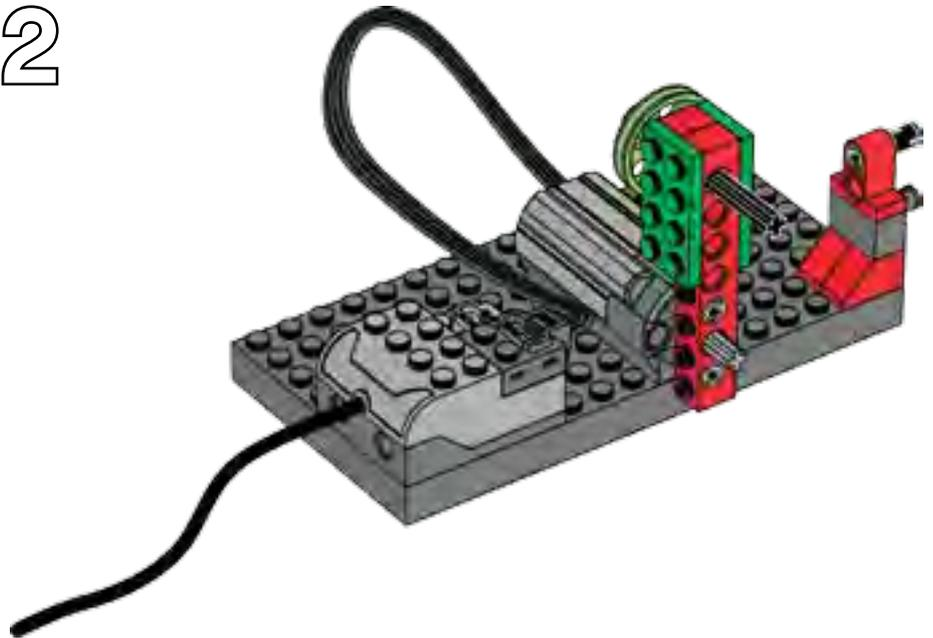



13

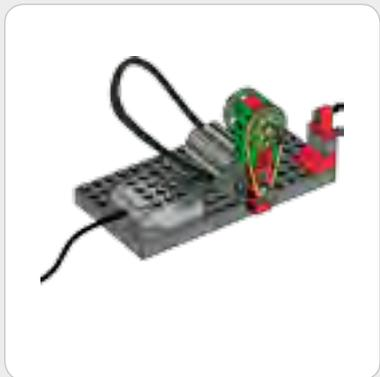
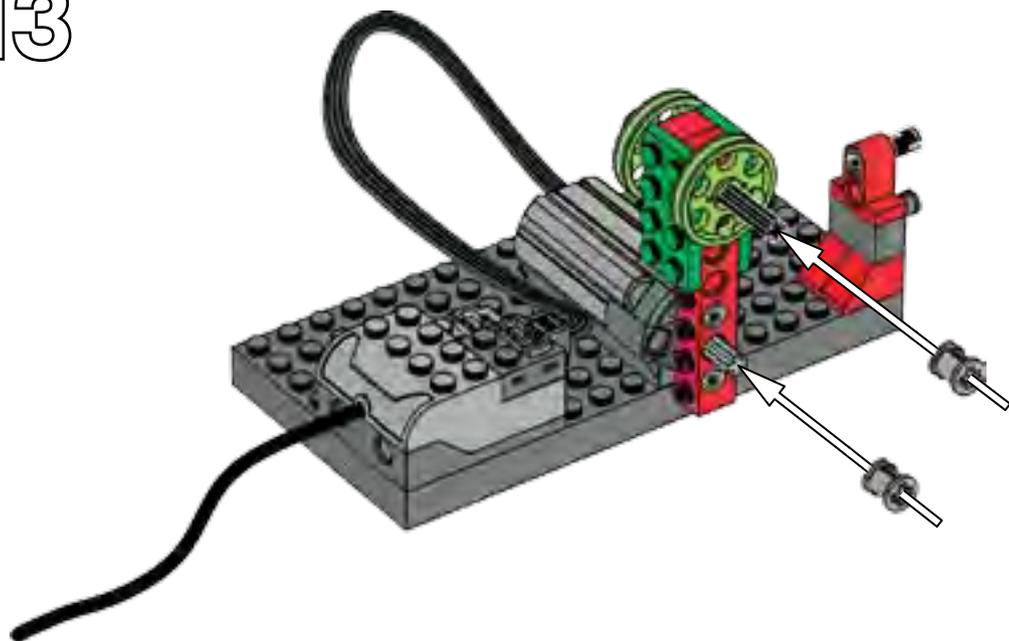

14

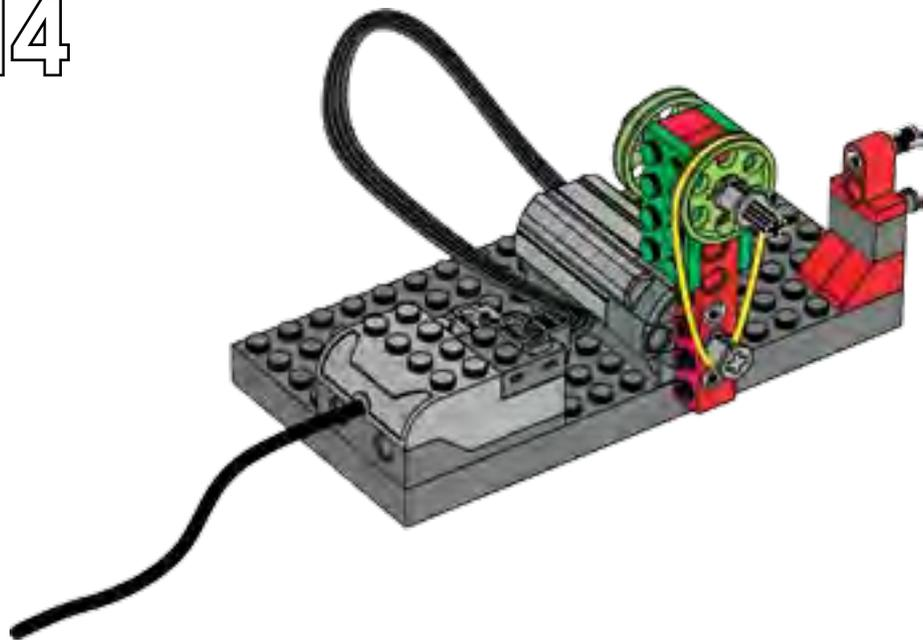





15

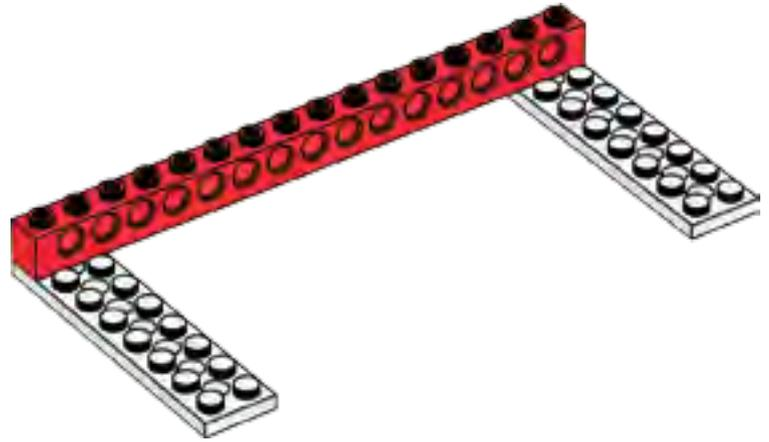

16

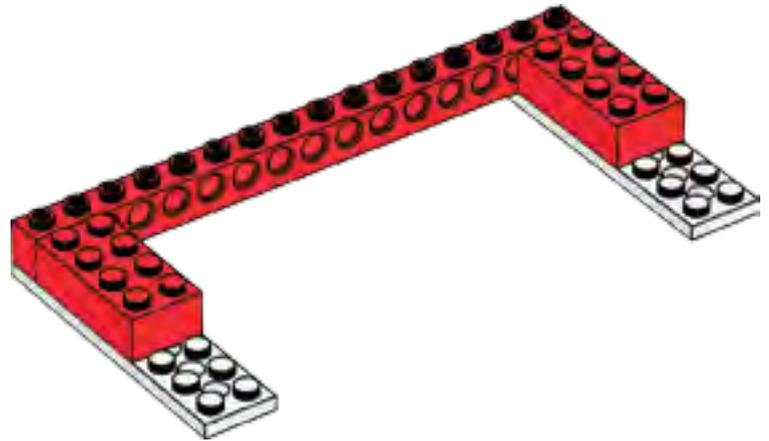

17

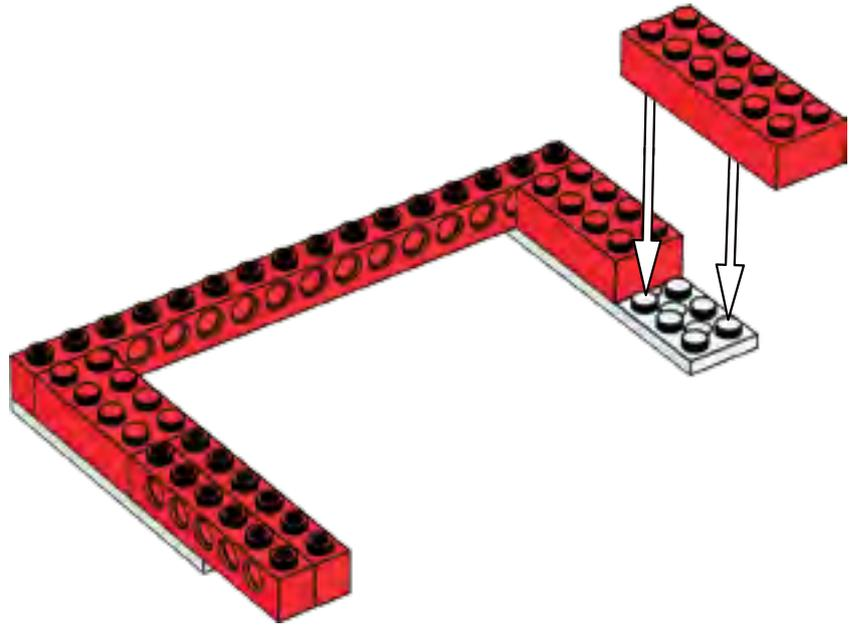

18

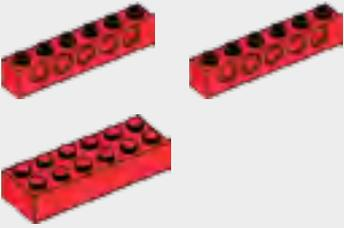
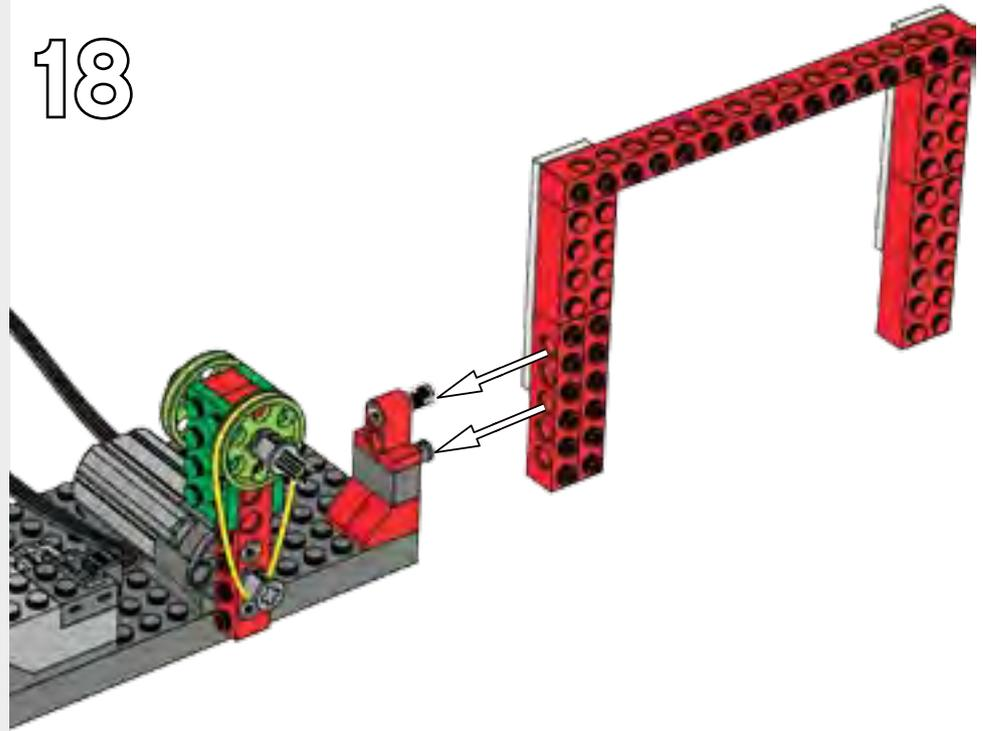



19



20

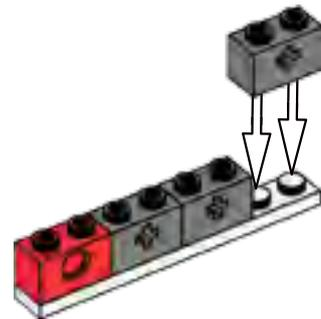

21

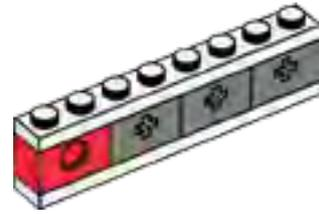

22

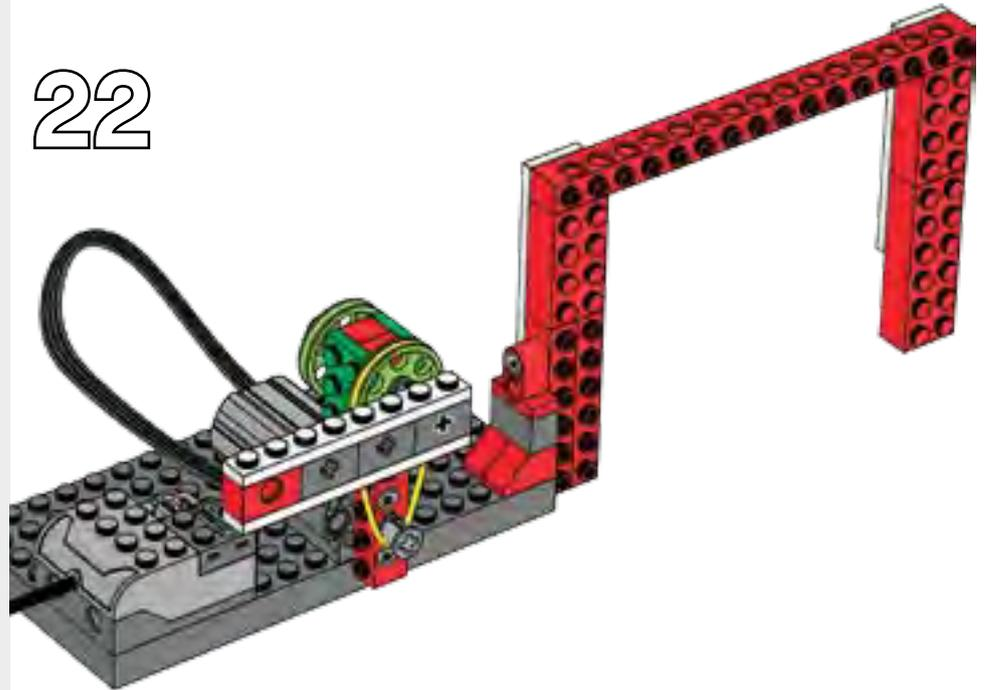



23

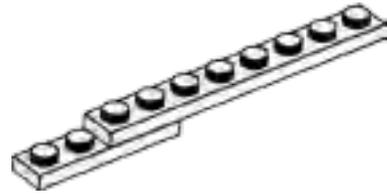

24

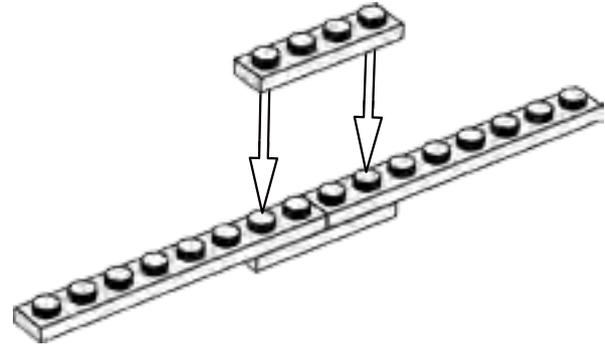



25

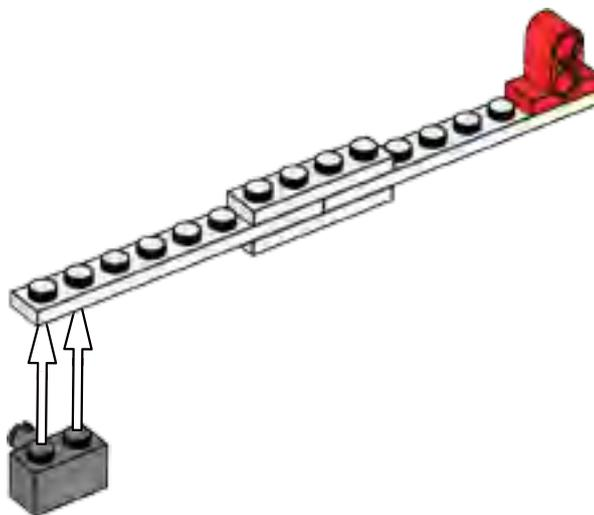

26

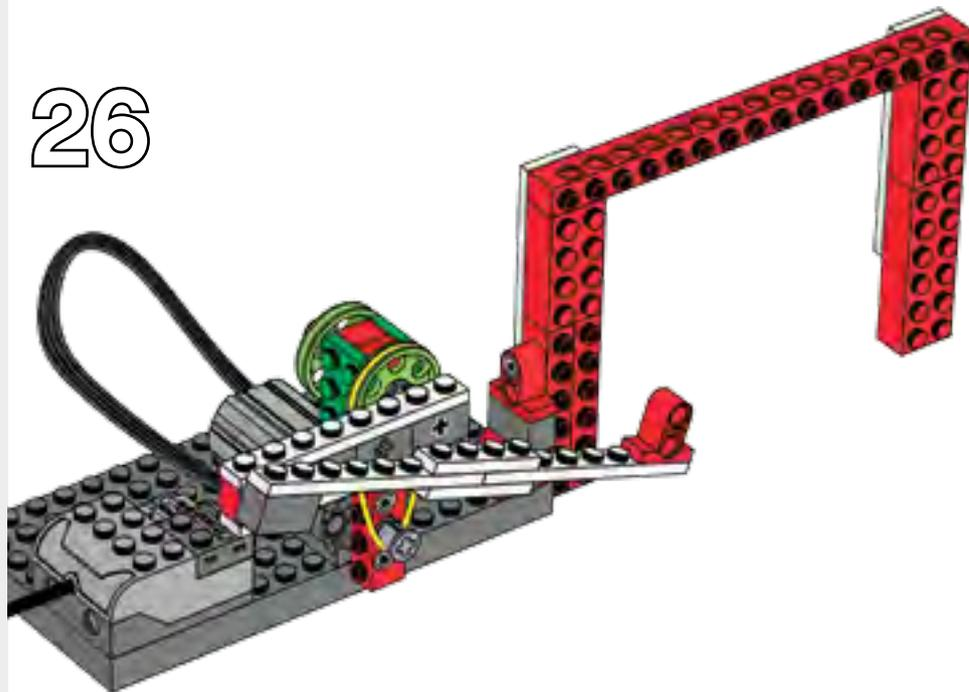



27

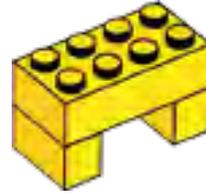

28

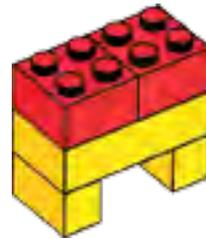



29

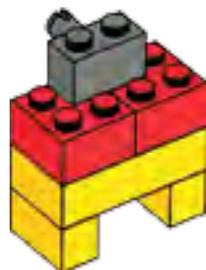

30

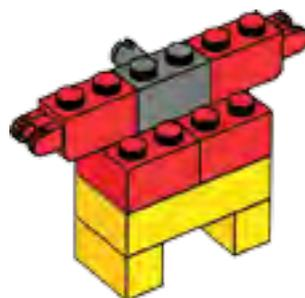





31

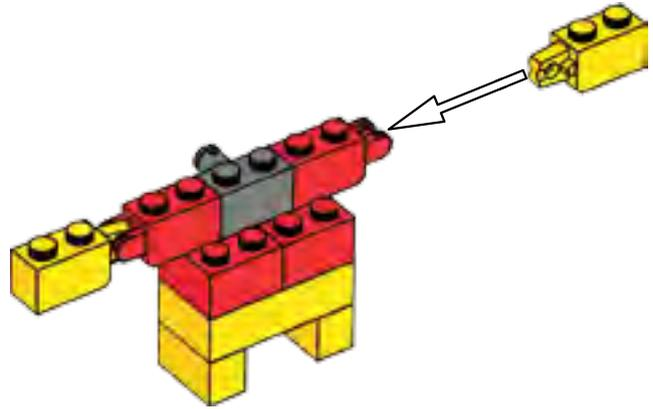

32

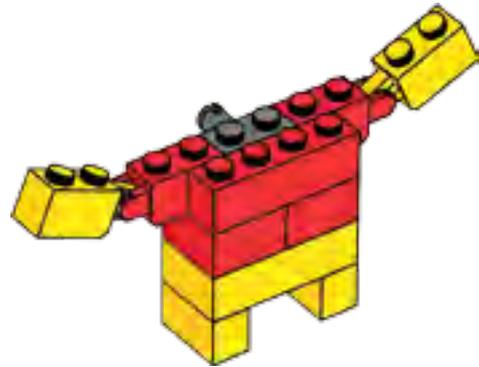

33

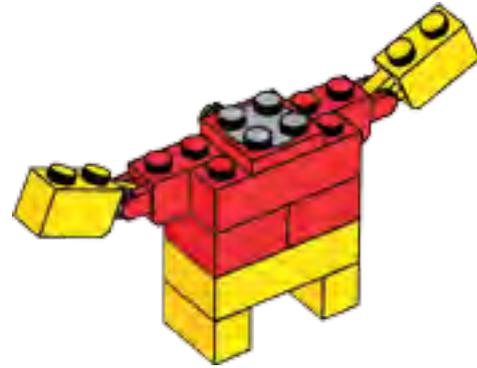

34

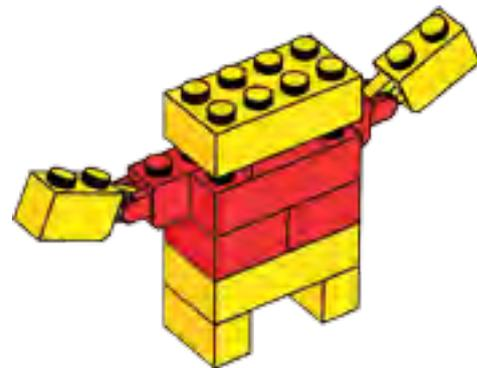



35

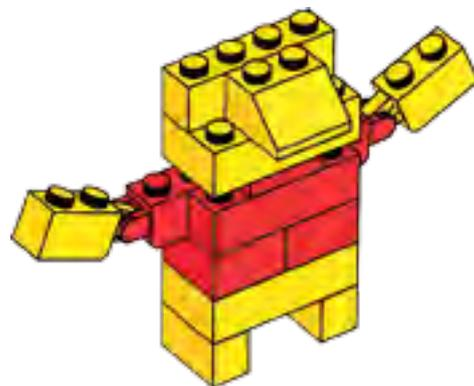

36

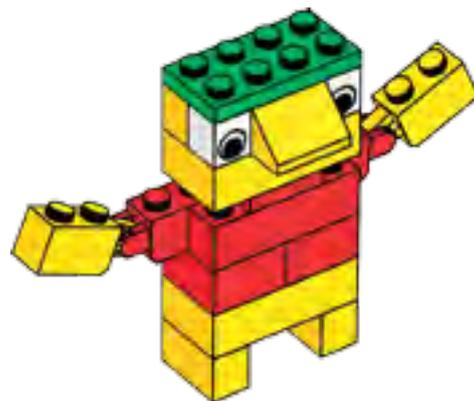

37

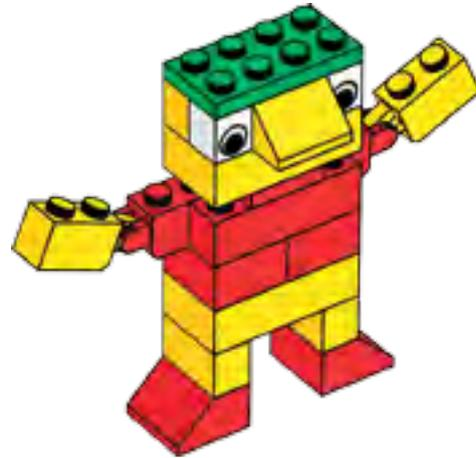

38

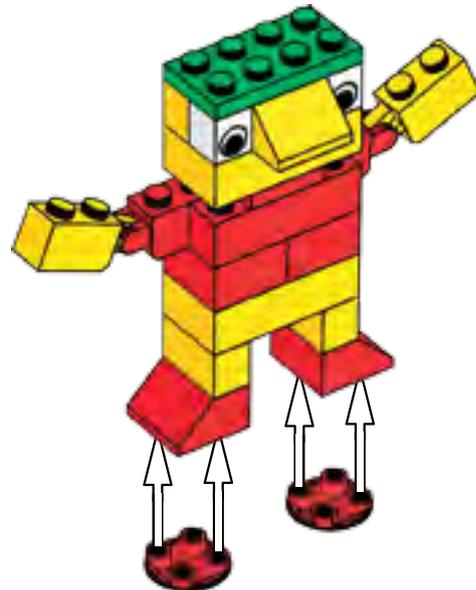
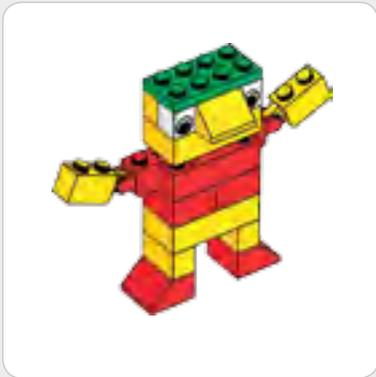



39

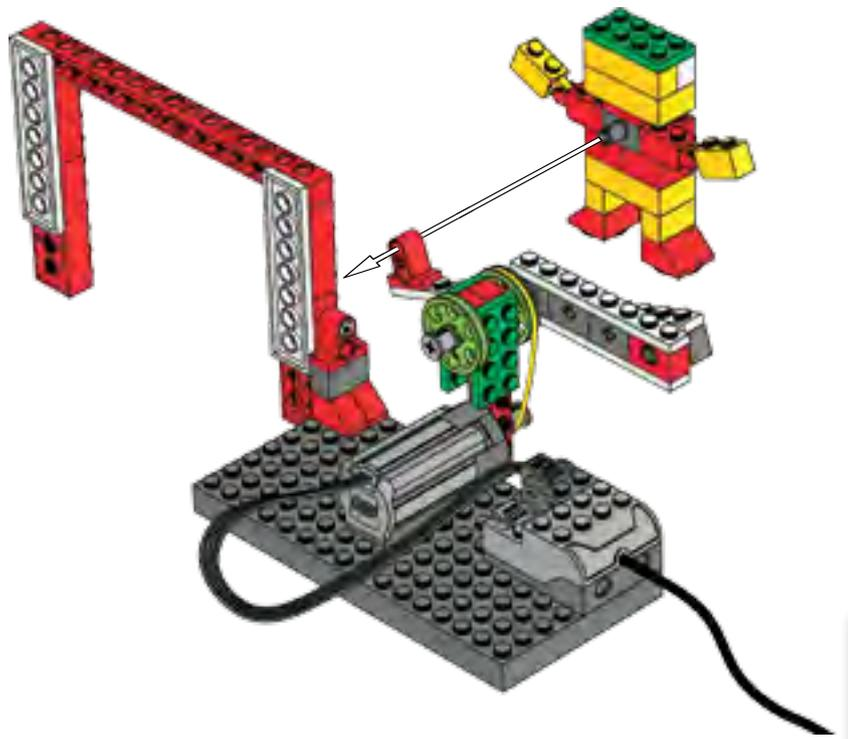

40

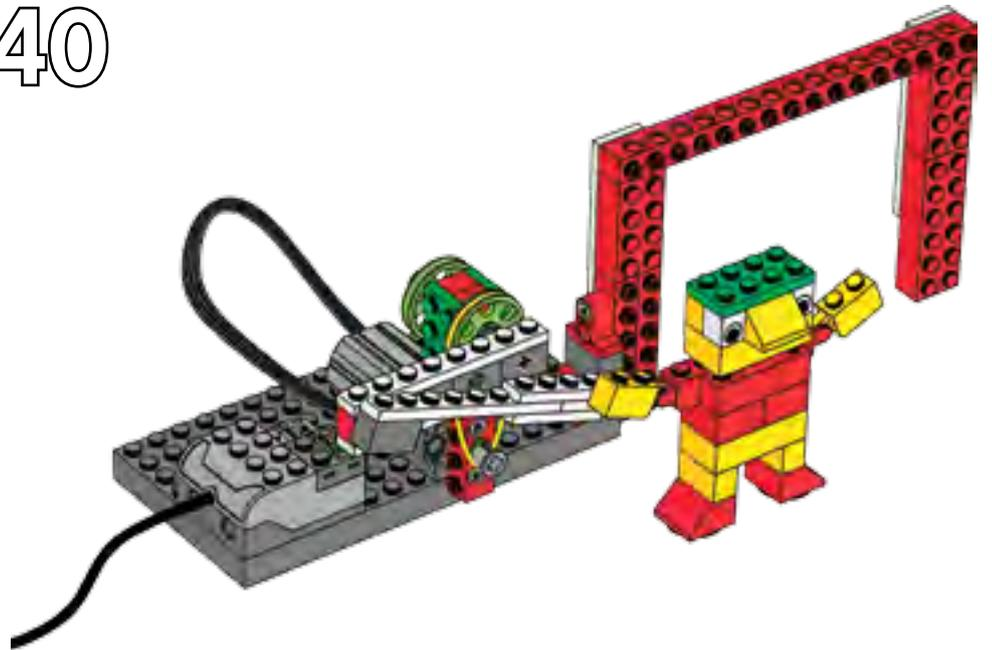

41

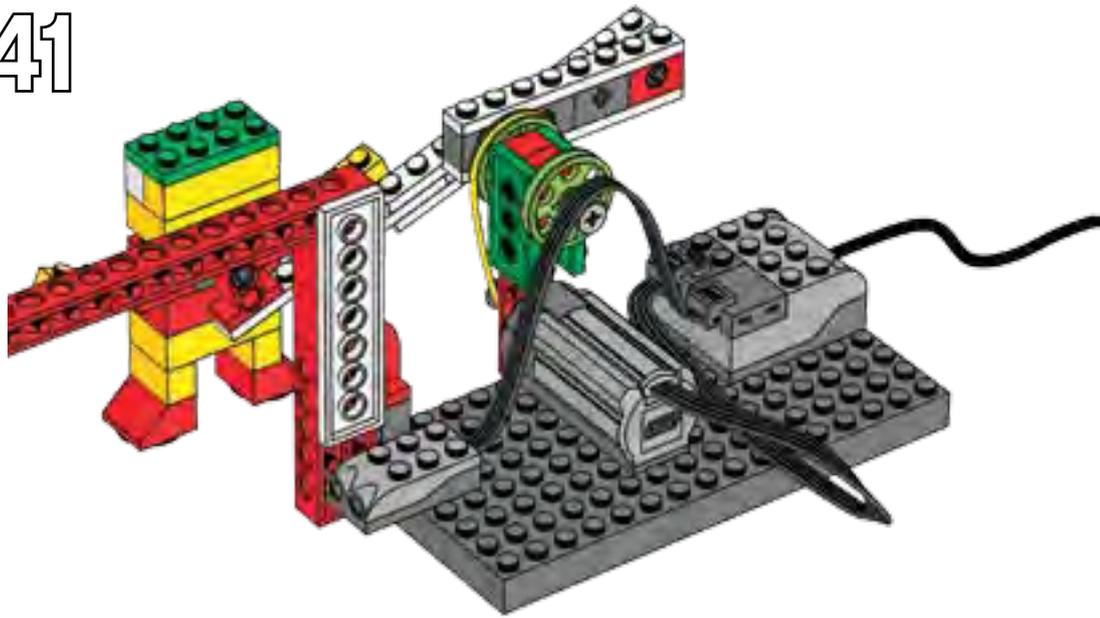

42

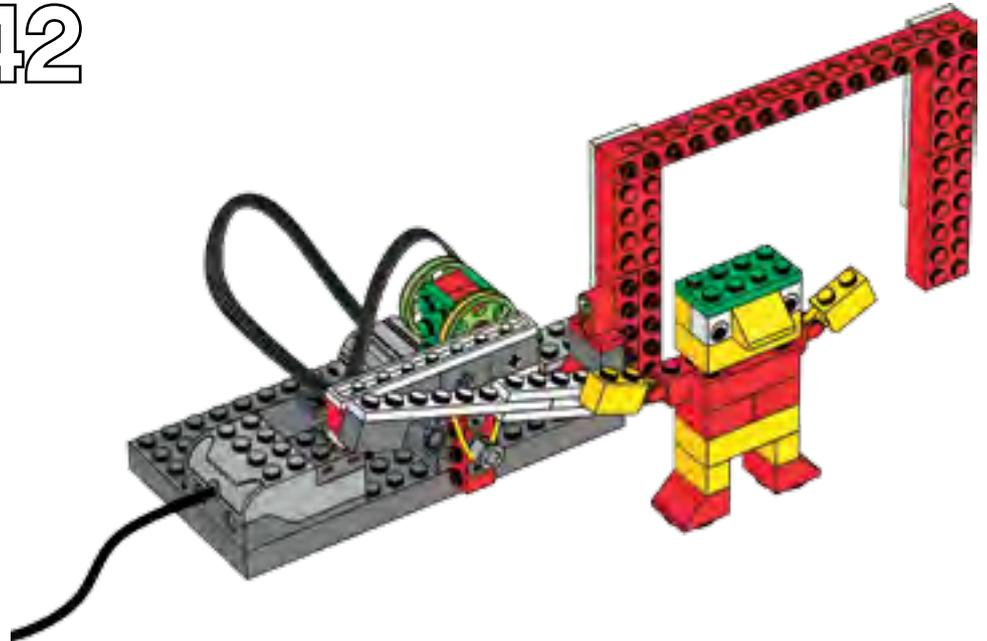

# Programación Robot

1



2

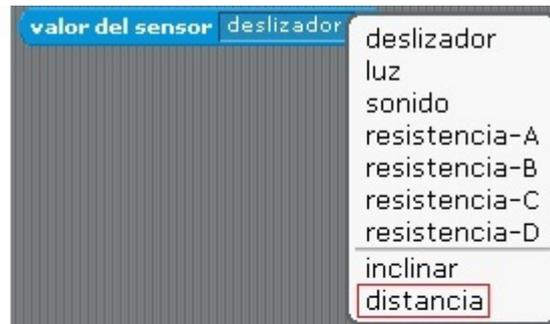

Z



F



{





5

