

1

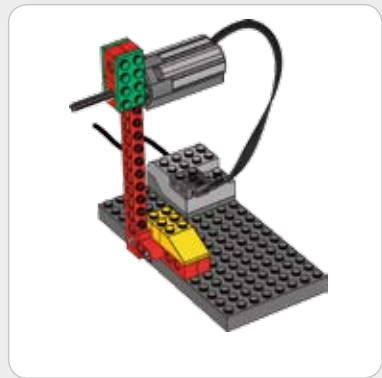

2

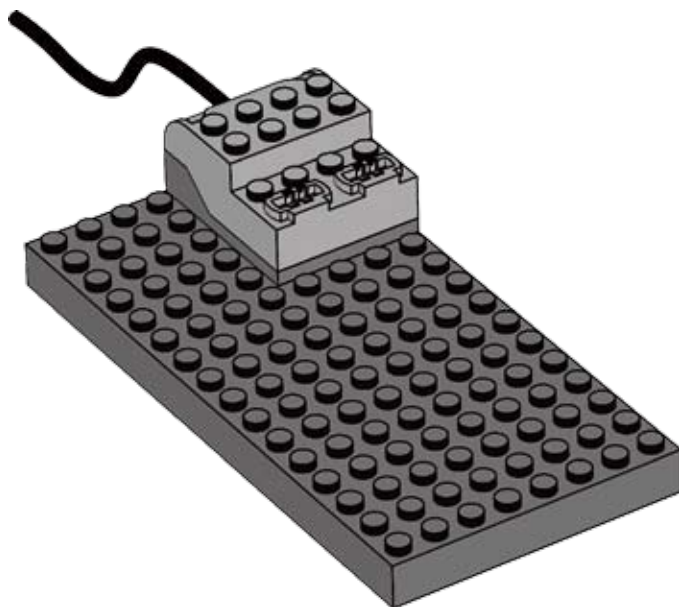

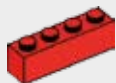
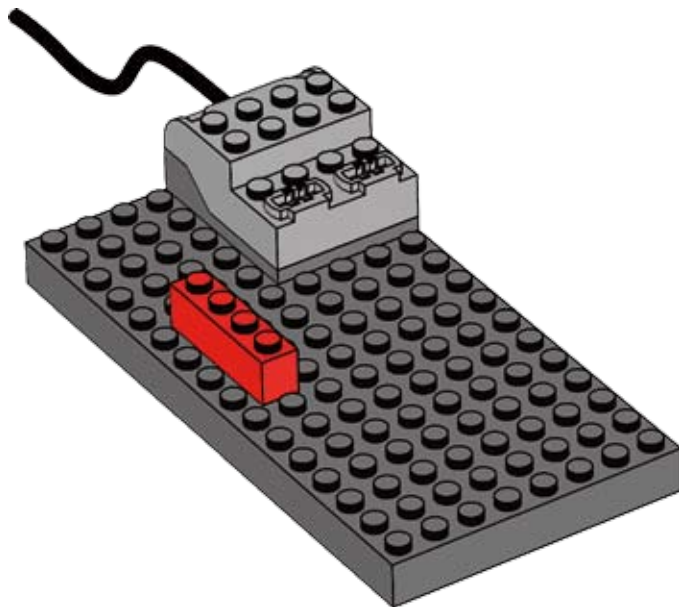
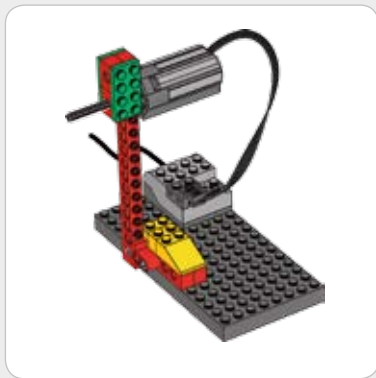

3

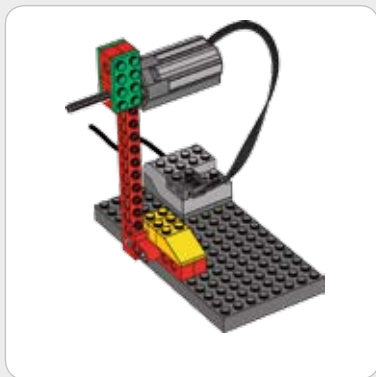
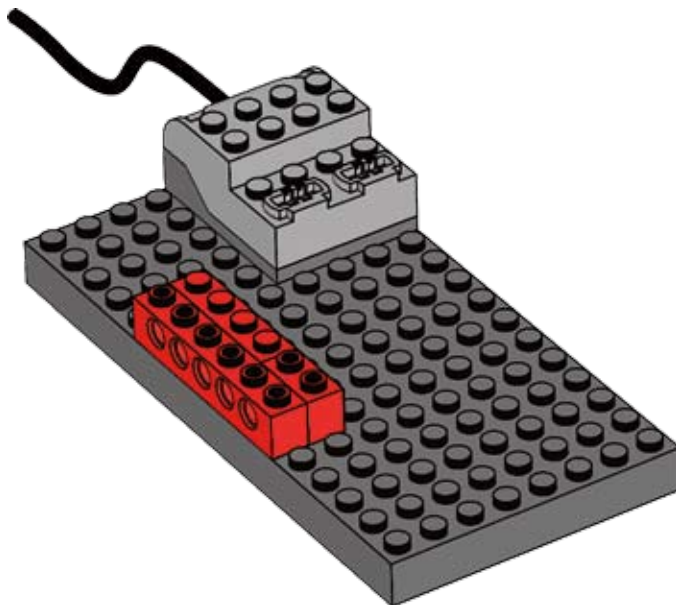

4

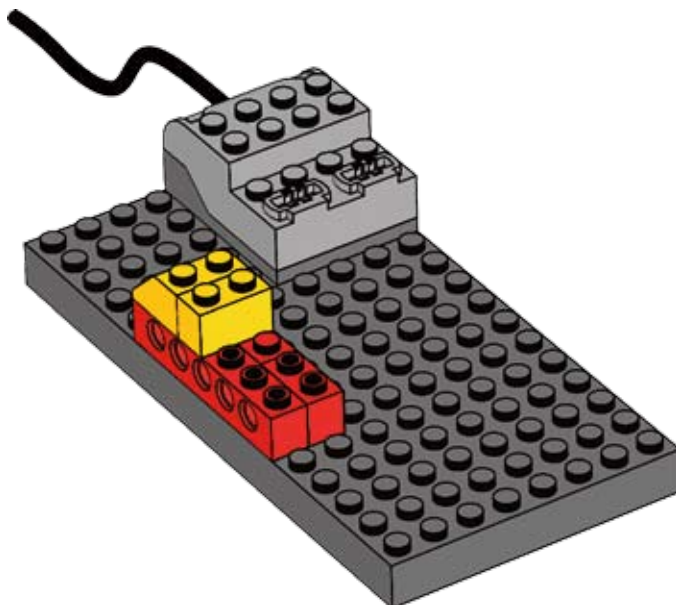

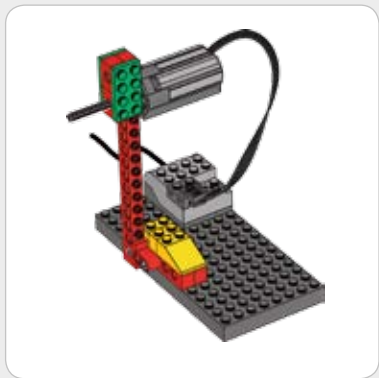

5

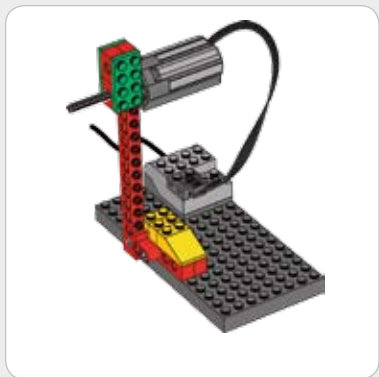
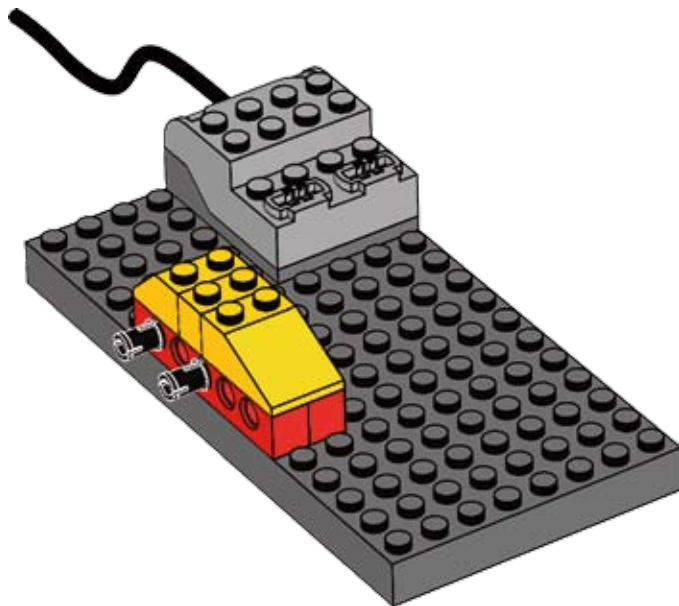

6

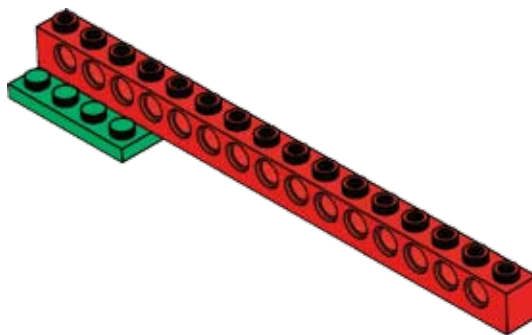
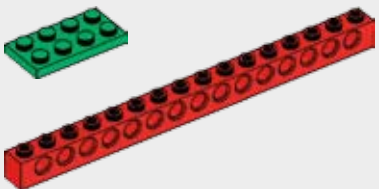



7

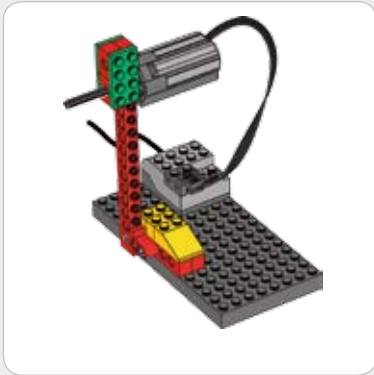
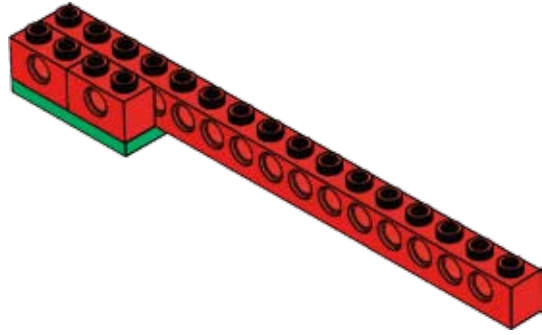

8

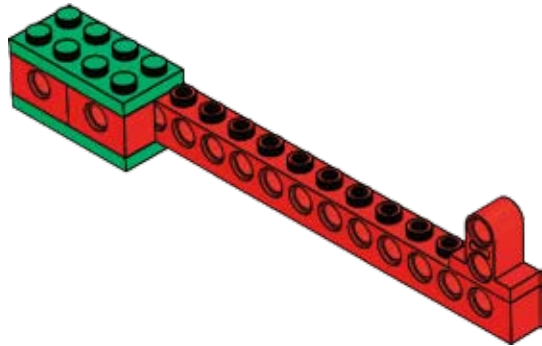



9

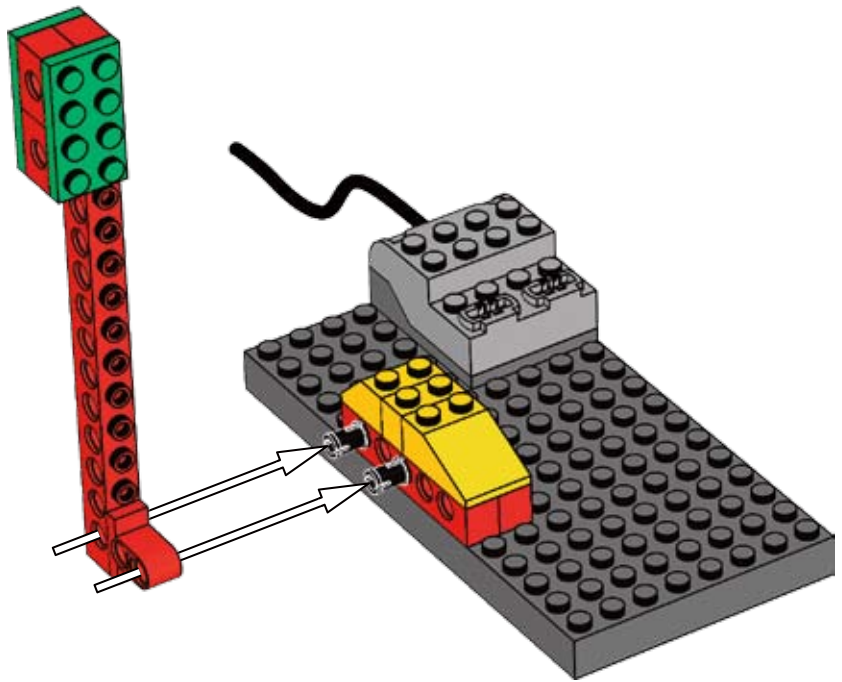

10

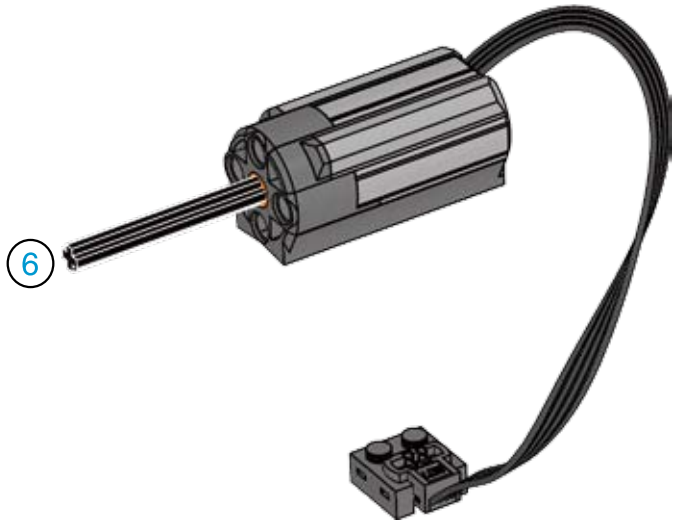

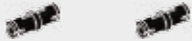

11

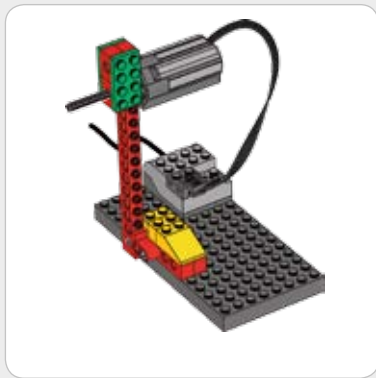

12

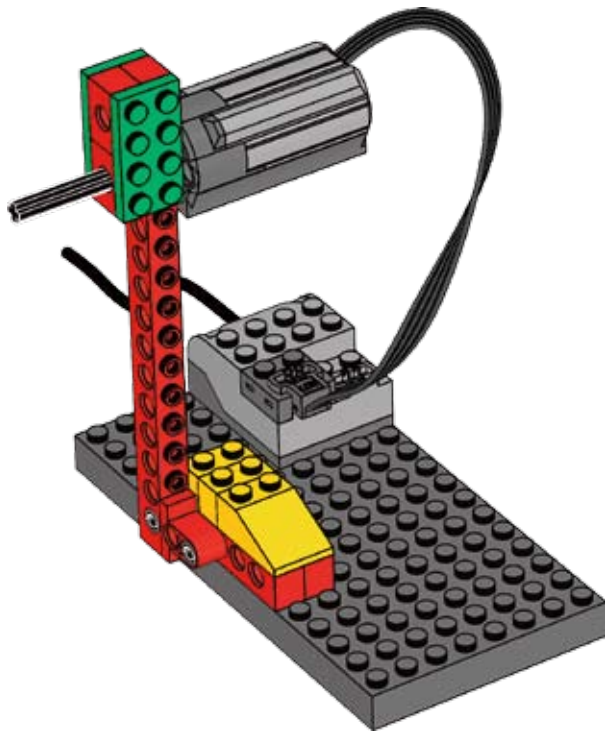

13

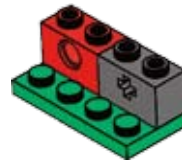
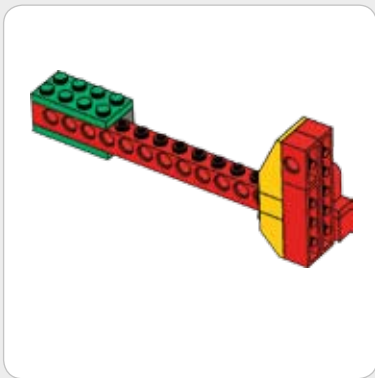

14

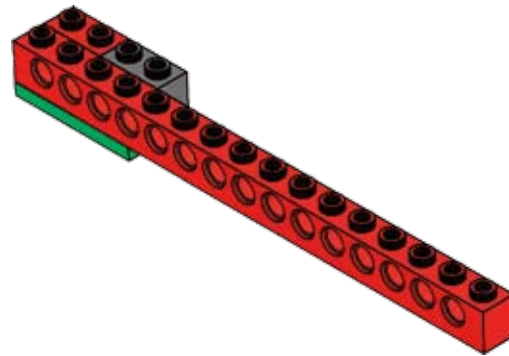
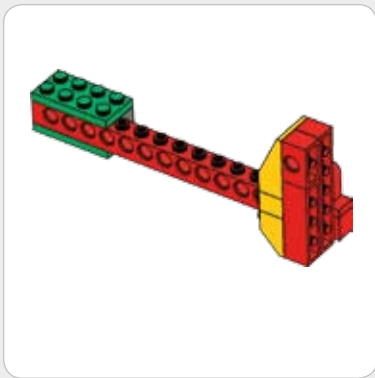

15

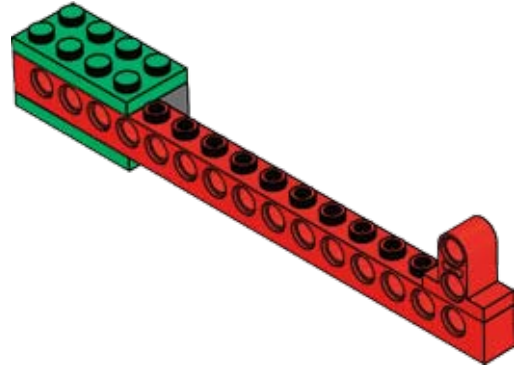
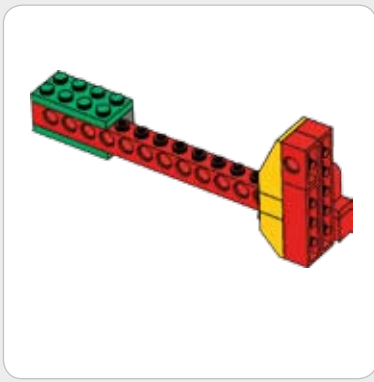

16

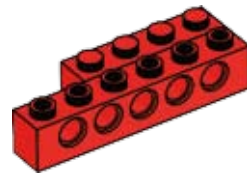
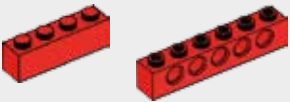
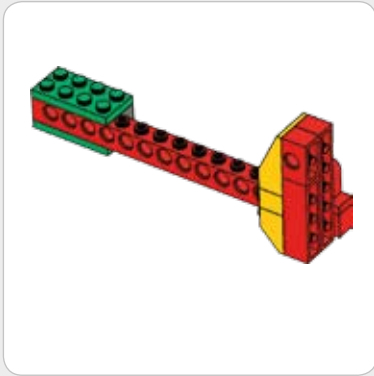

17

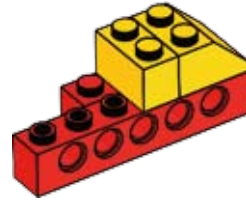
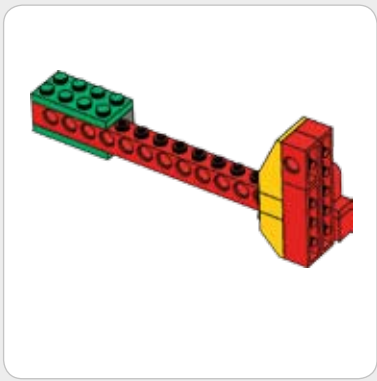

18

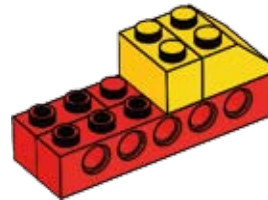
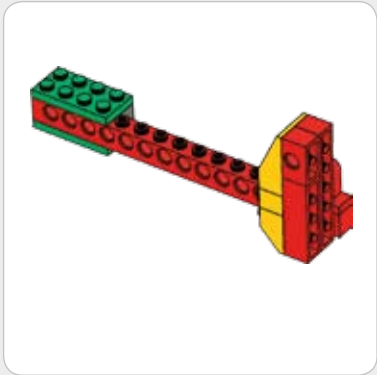

19

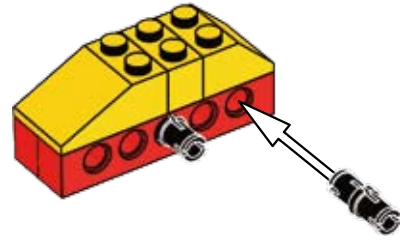
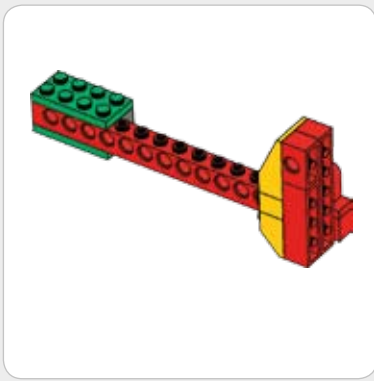

20

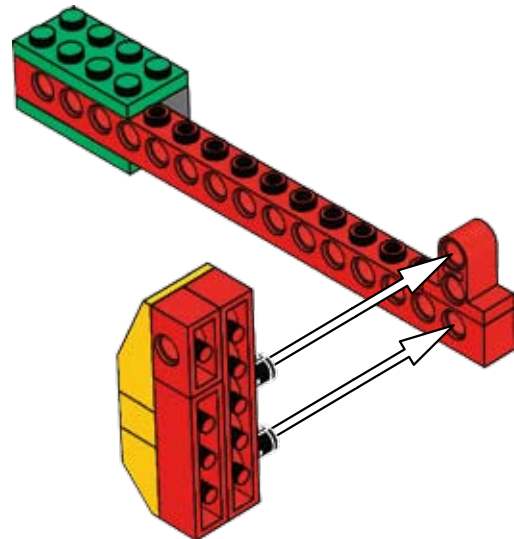
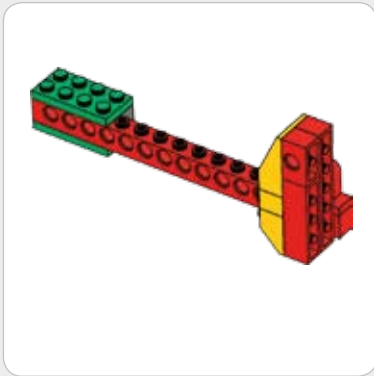

21

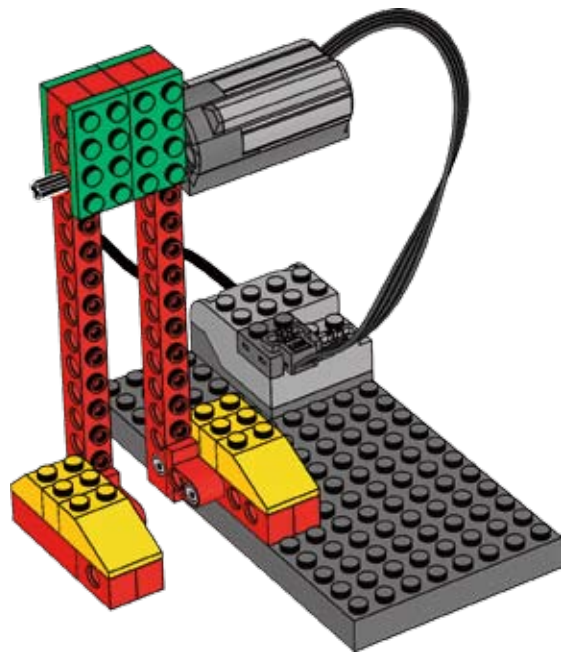



22

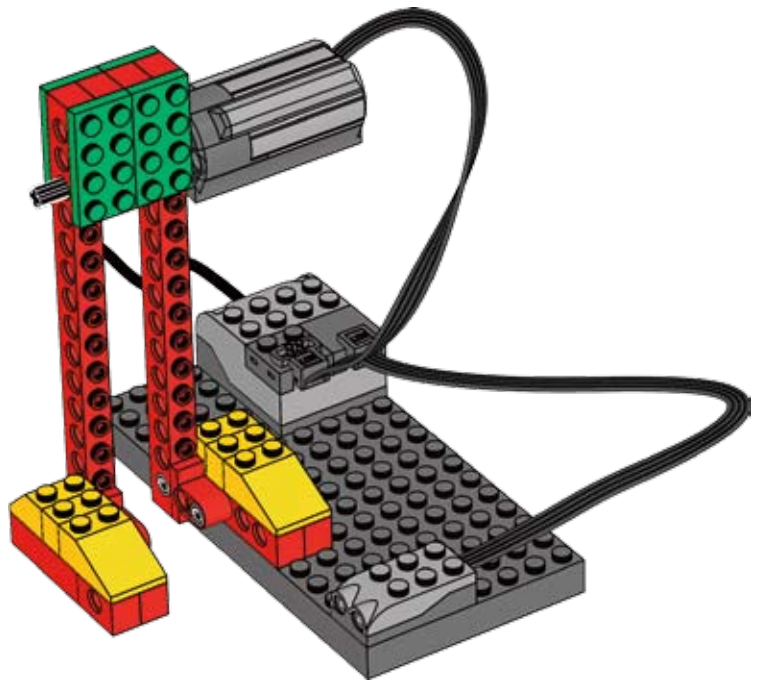
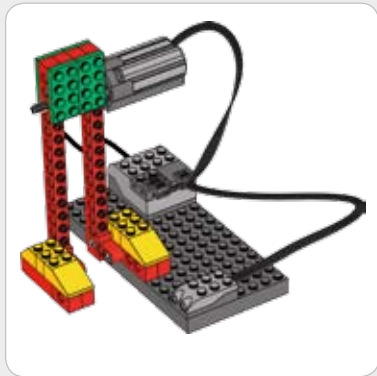

Programación Robot

1



2

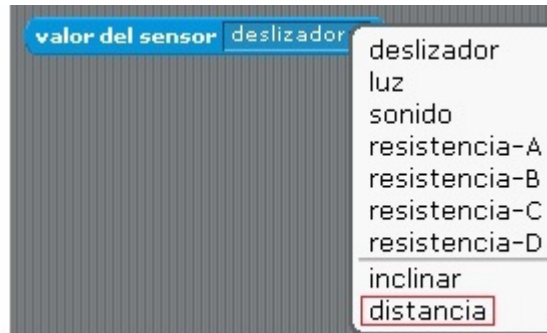

3



4

