

1

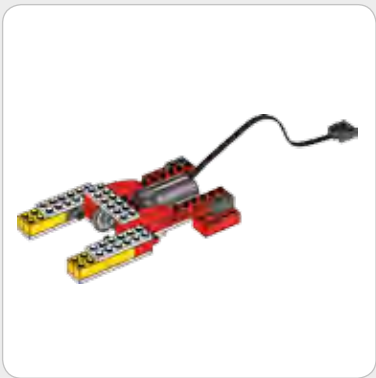

2

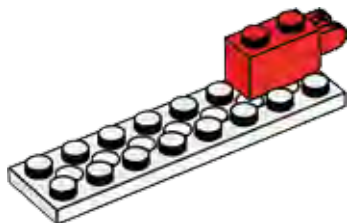

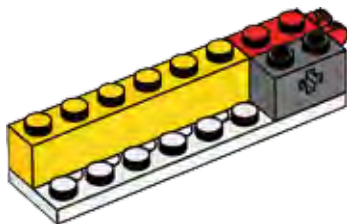
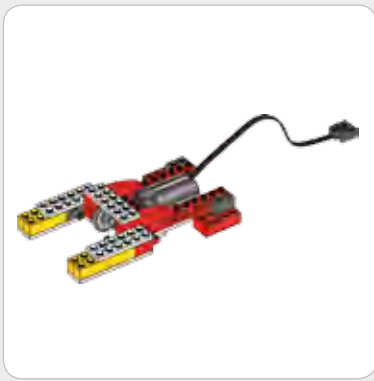

3

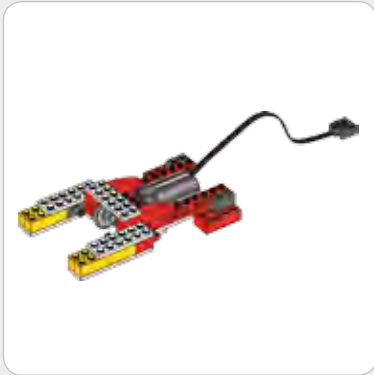
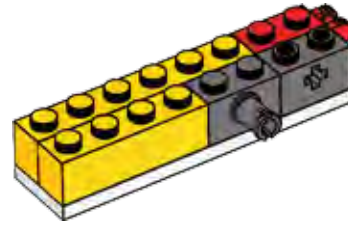

4

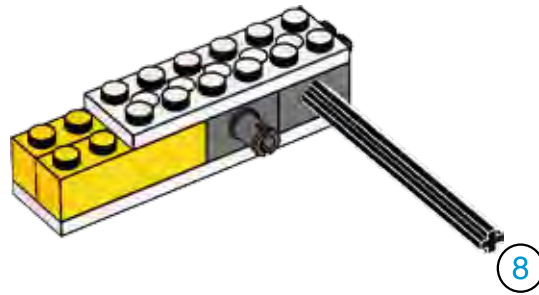

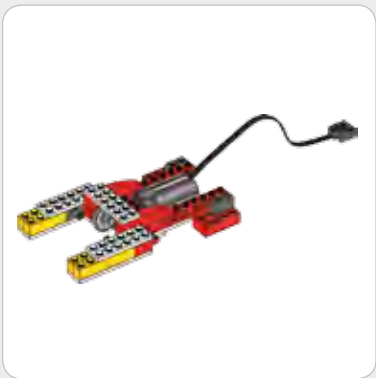

5

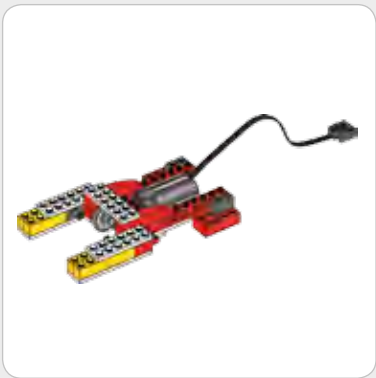
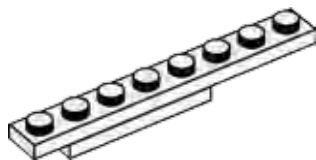

6

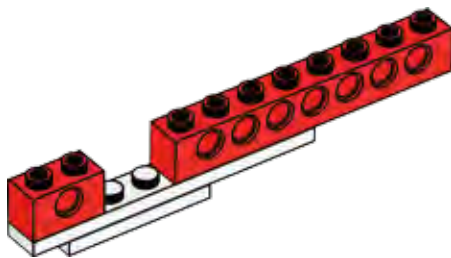

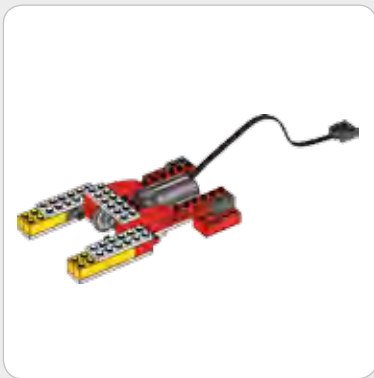

7

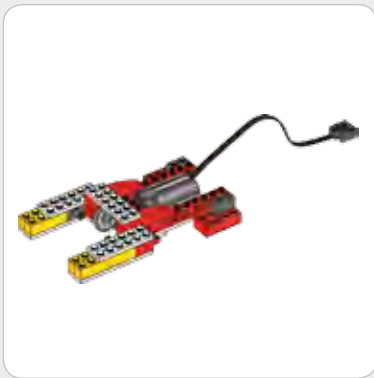
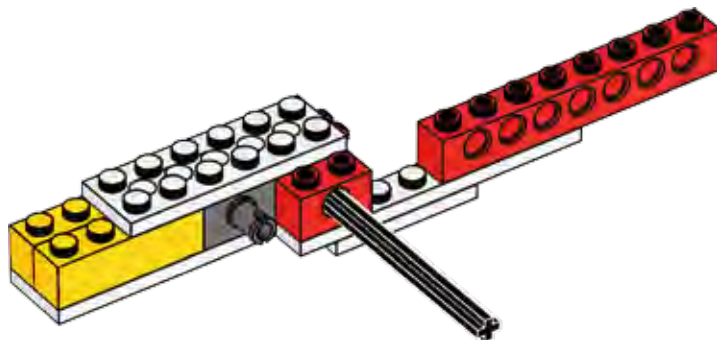

8

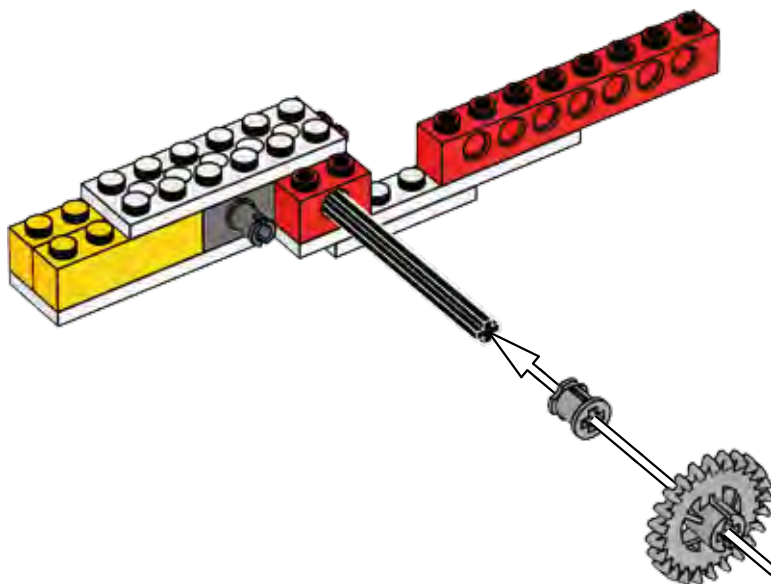

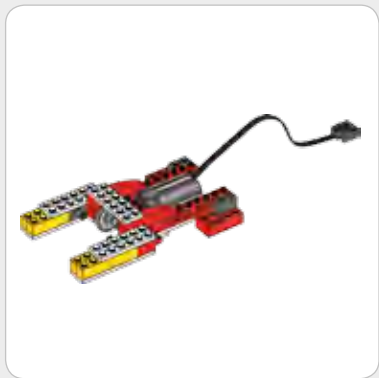

9

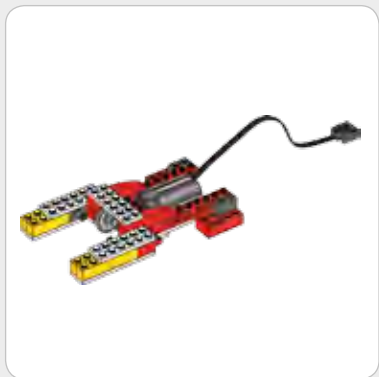
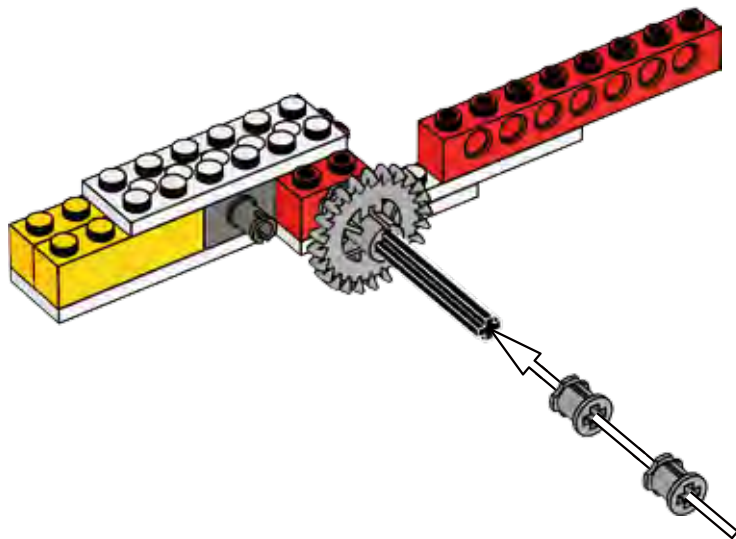

10

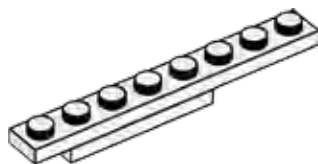

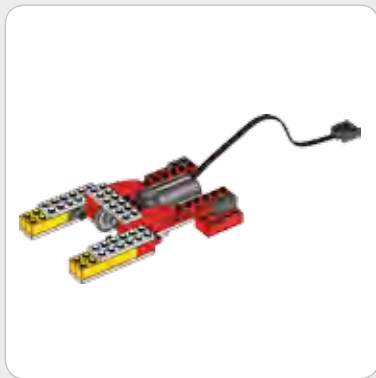

11

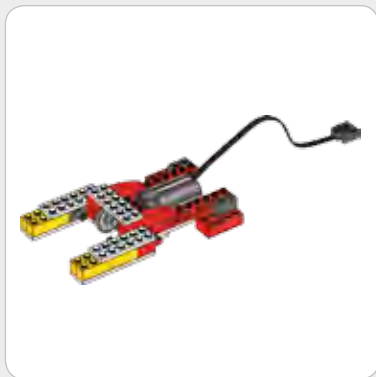
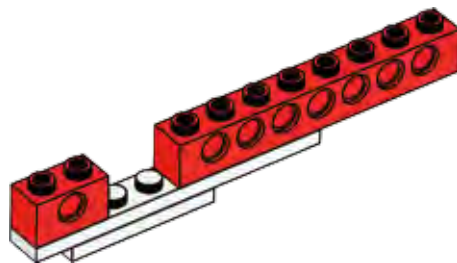

12

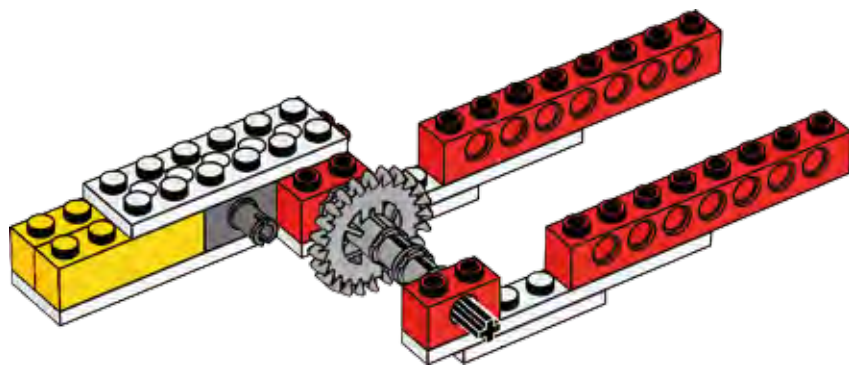

13

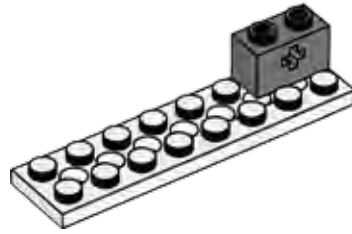
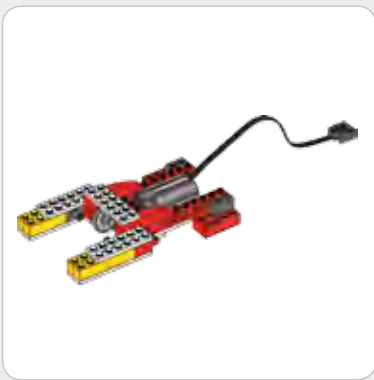

14

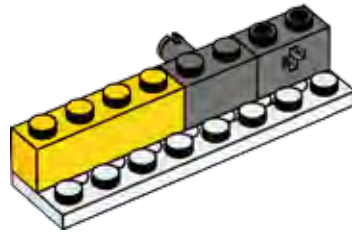
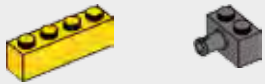
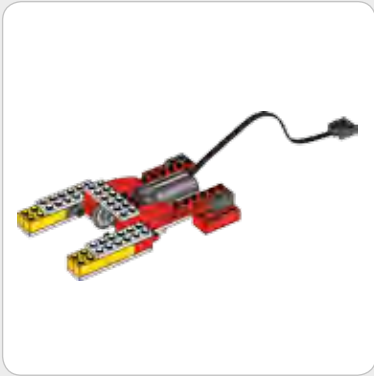

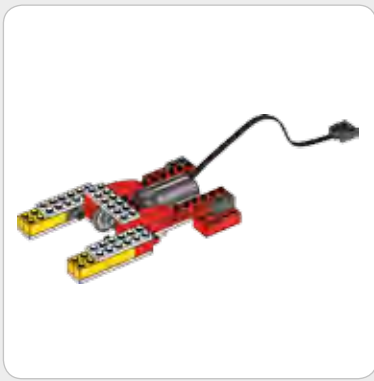

15

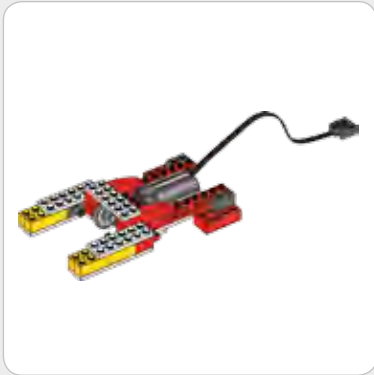
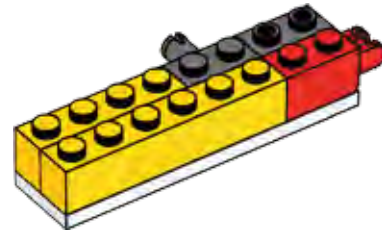

16

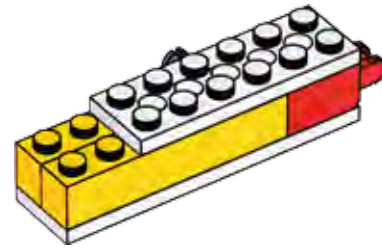

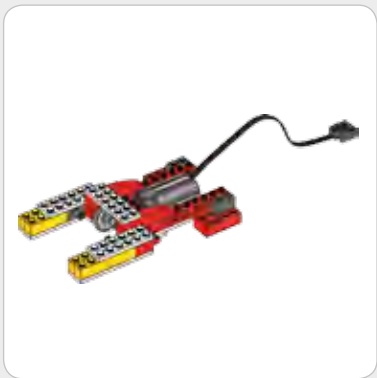

17

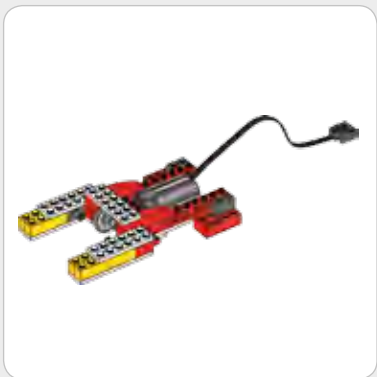
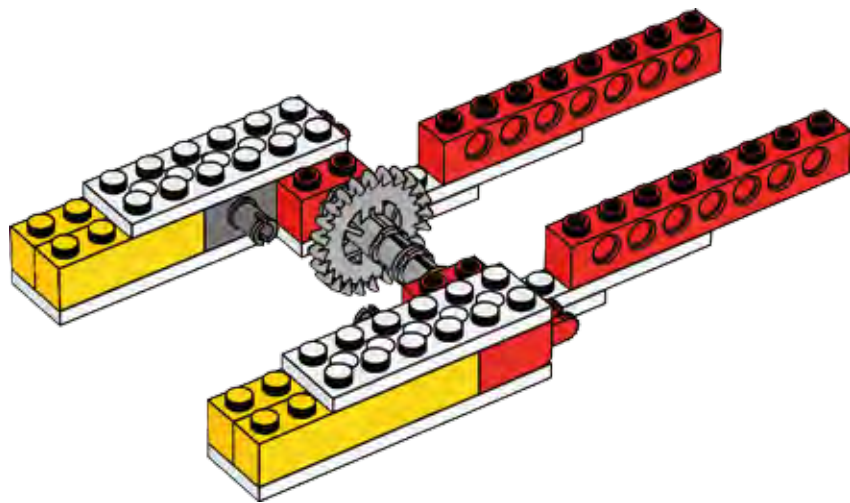

18

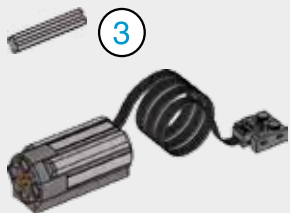

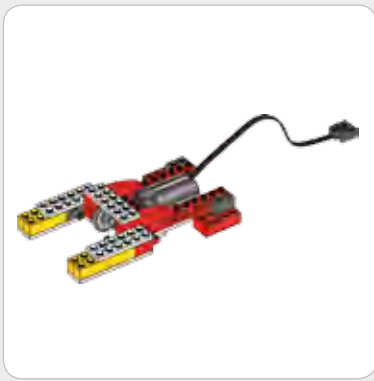

19

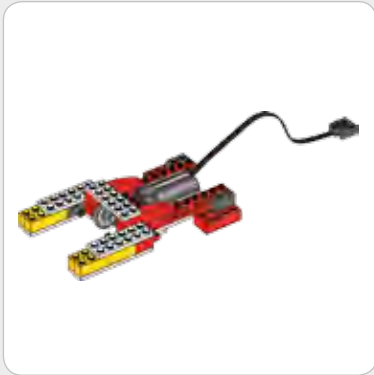
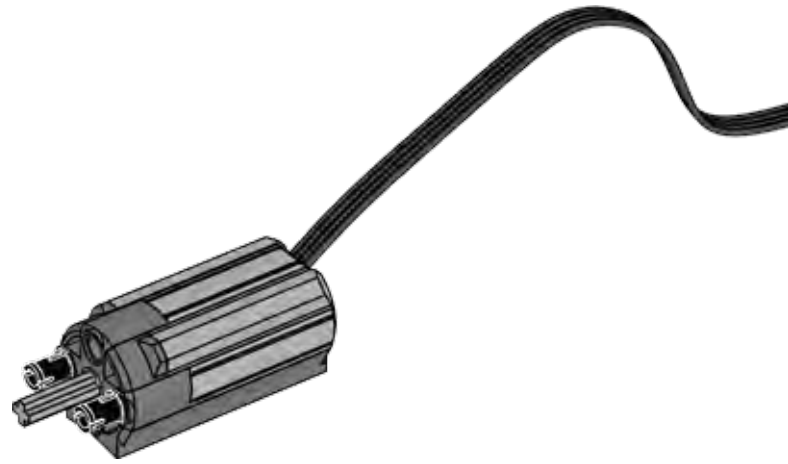

20

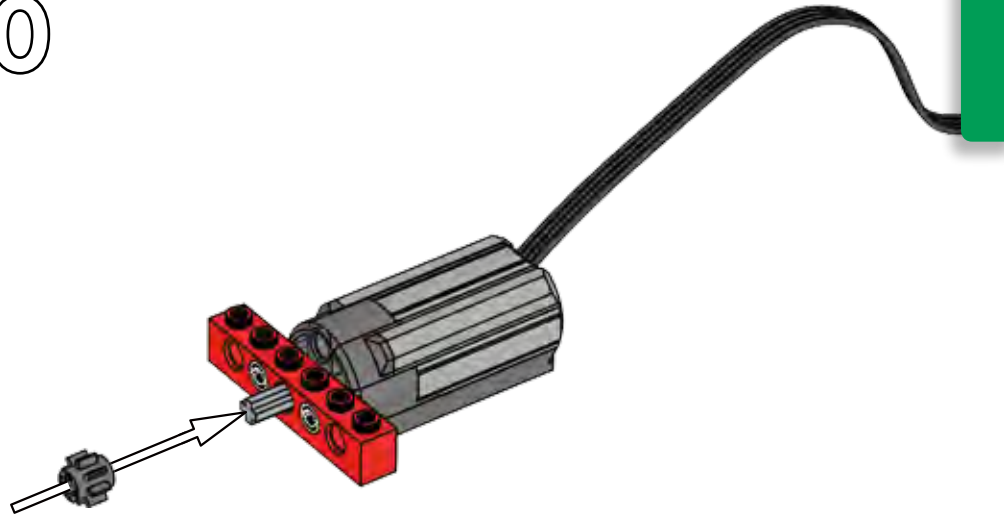

21

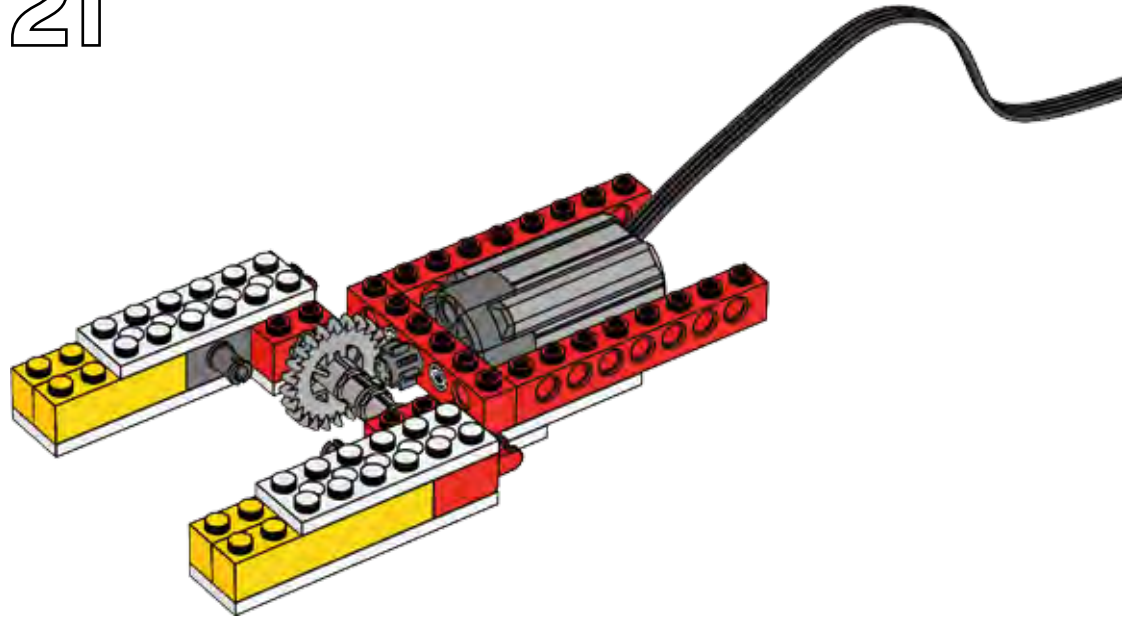
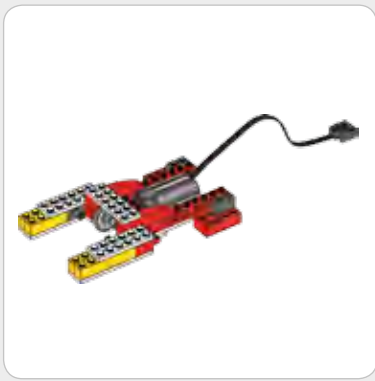

22

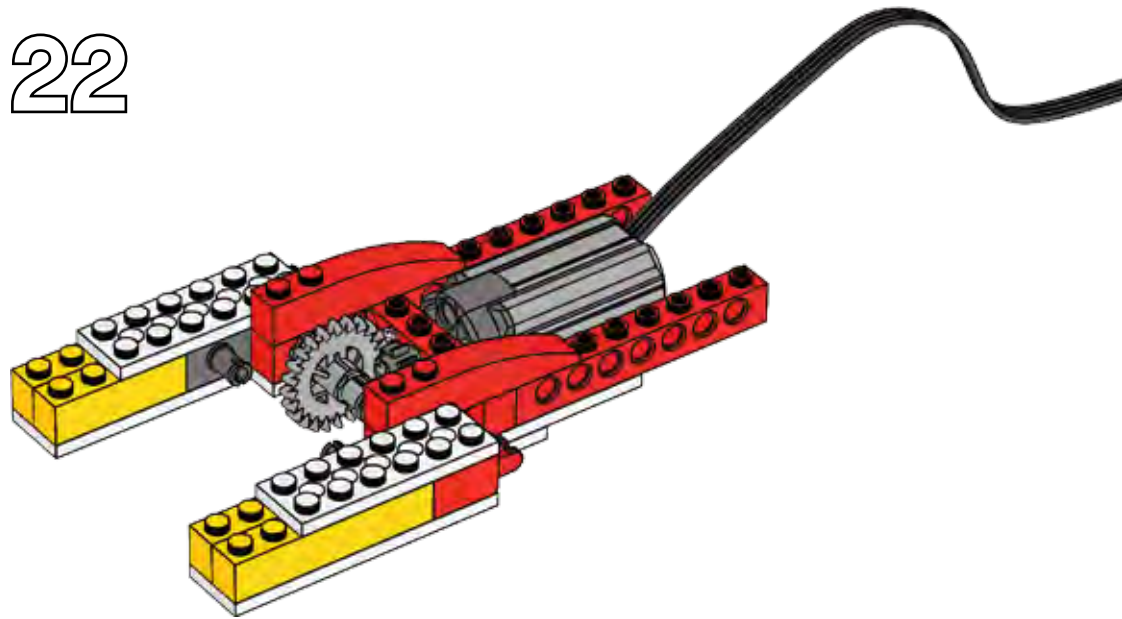
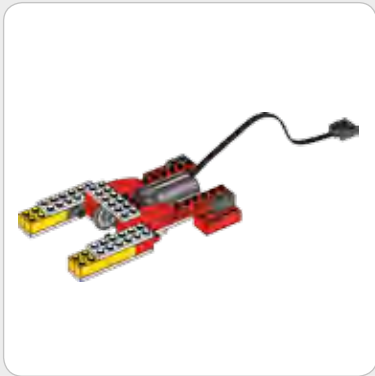

23

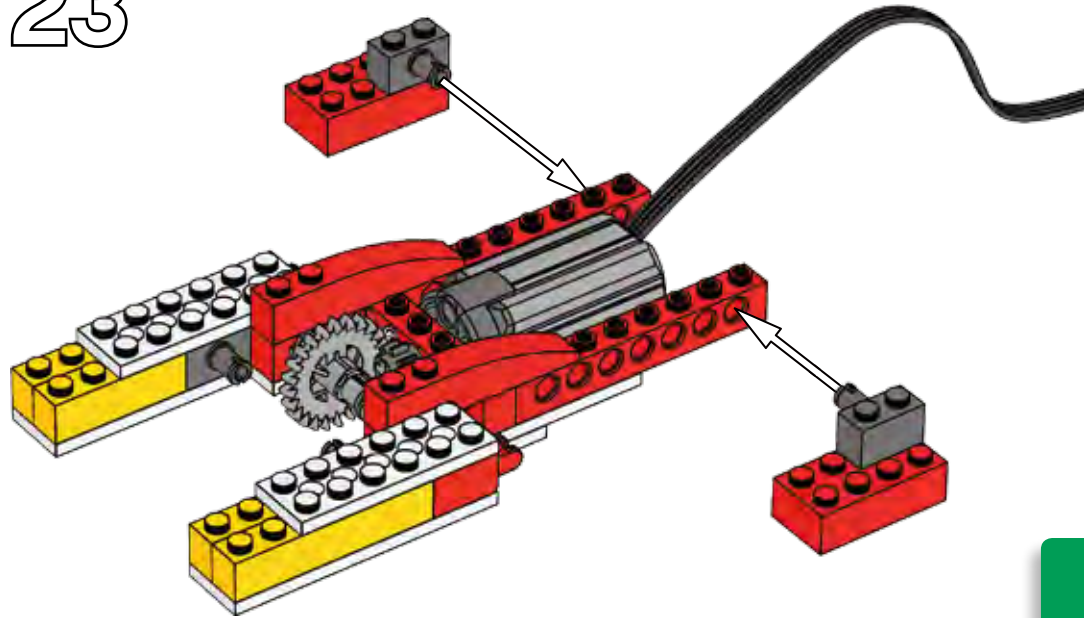
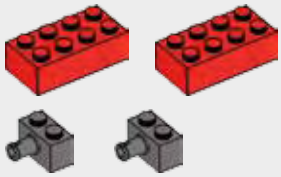
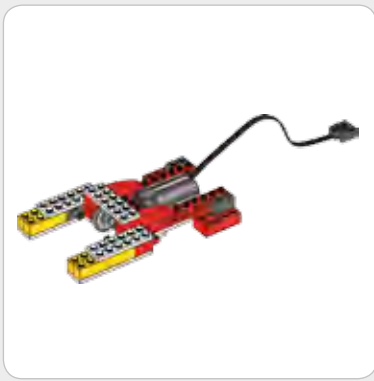

24

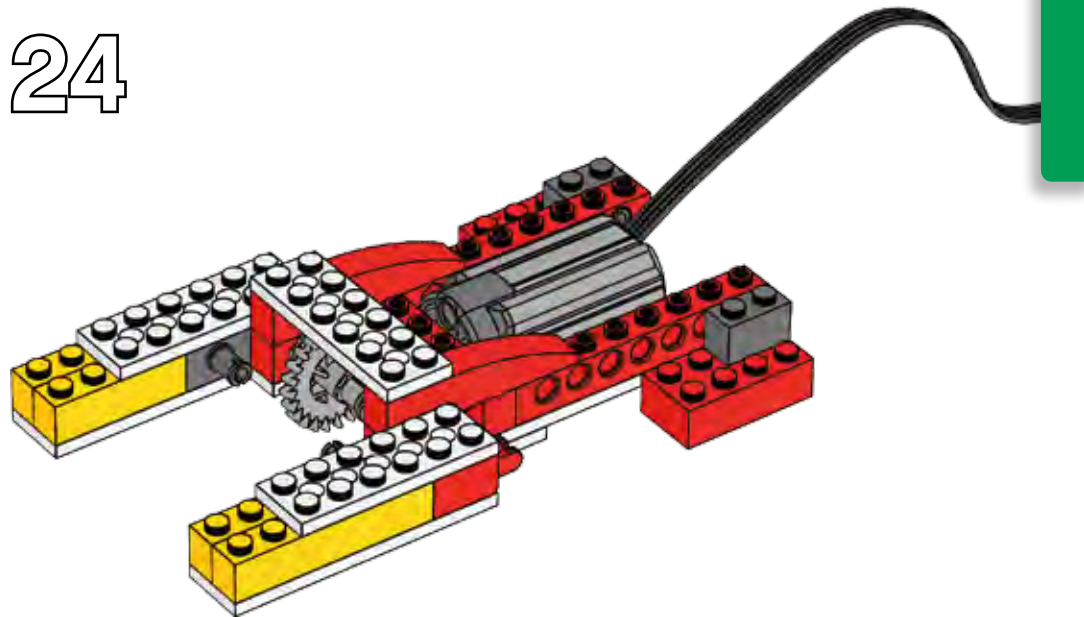
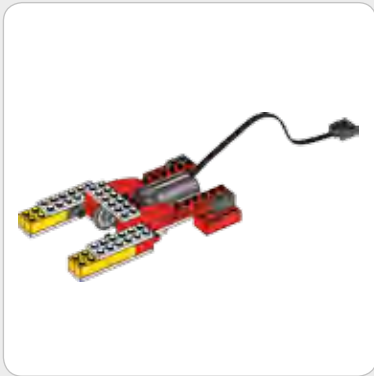

25

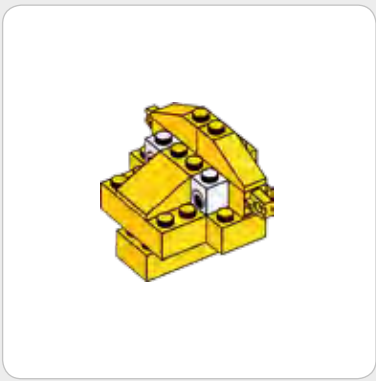

26

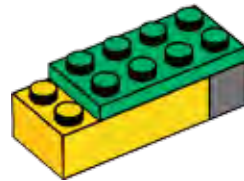
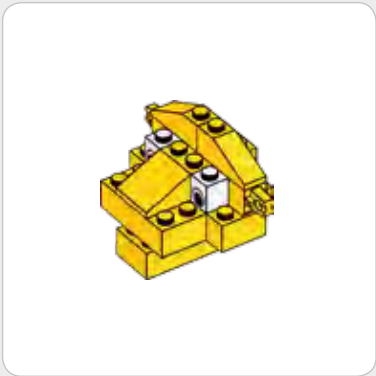

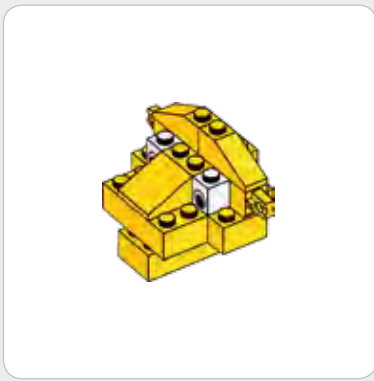

27

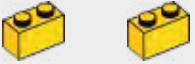
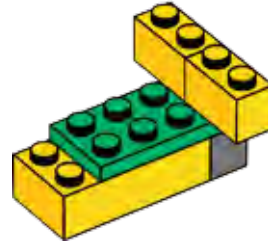

28

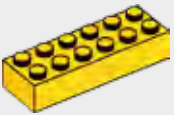
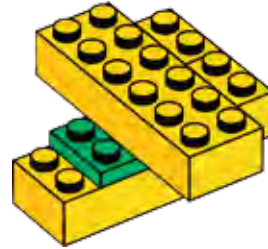

29

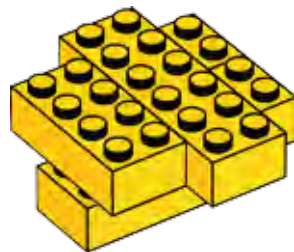

30

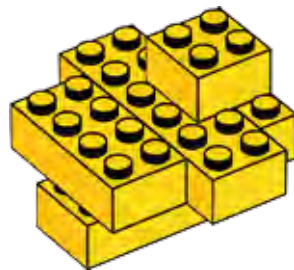
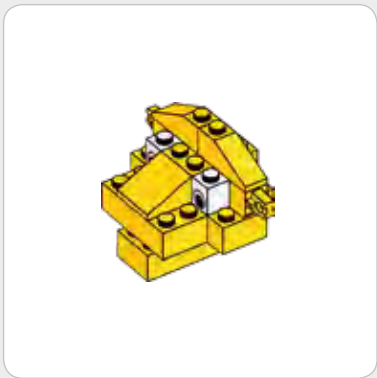

31

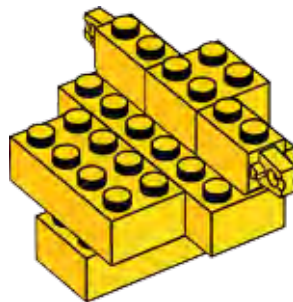

32

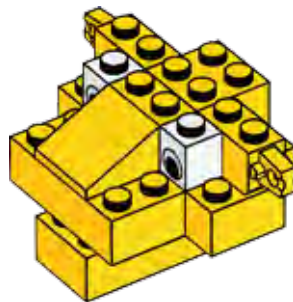

33

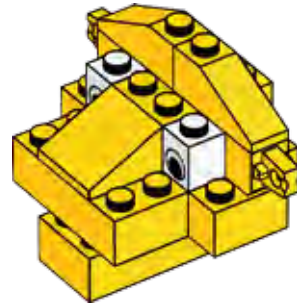

34

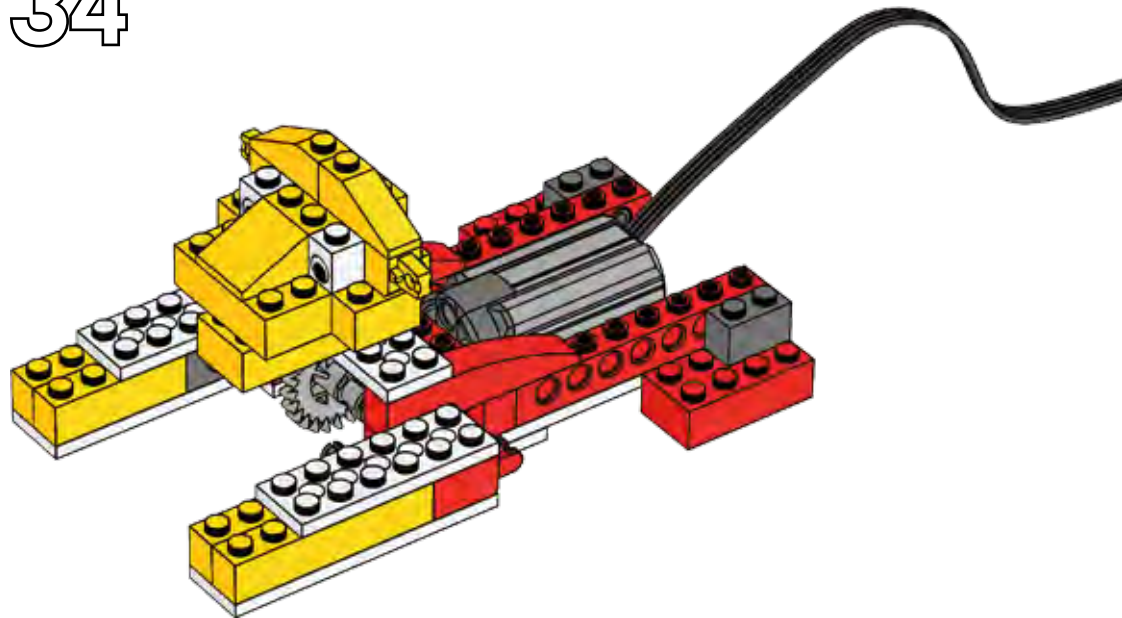
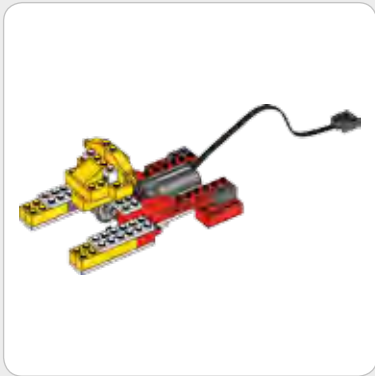

35

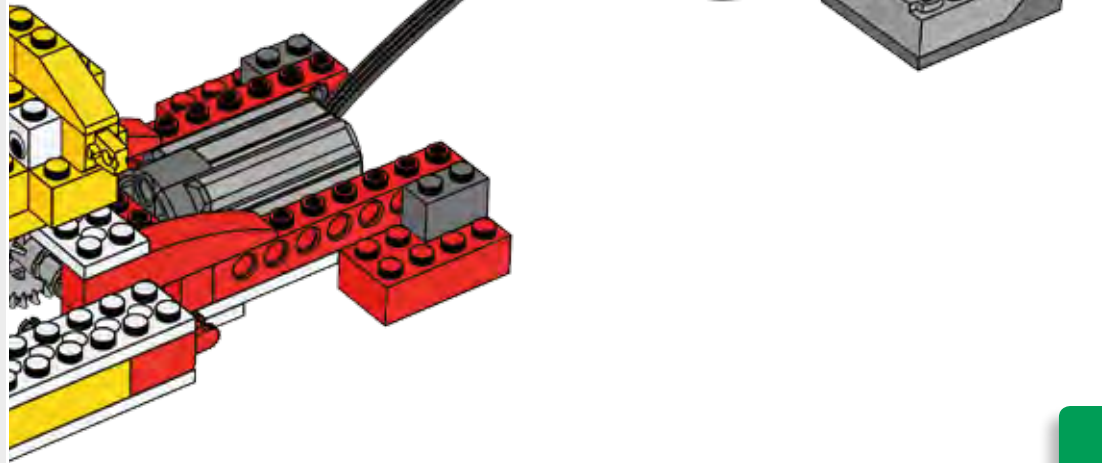

36

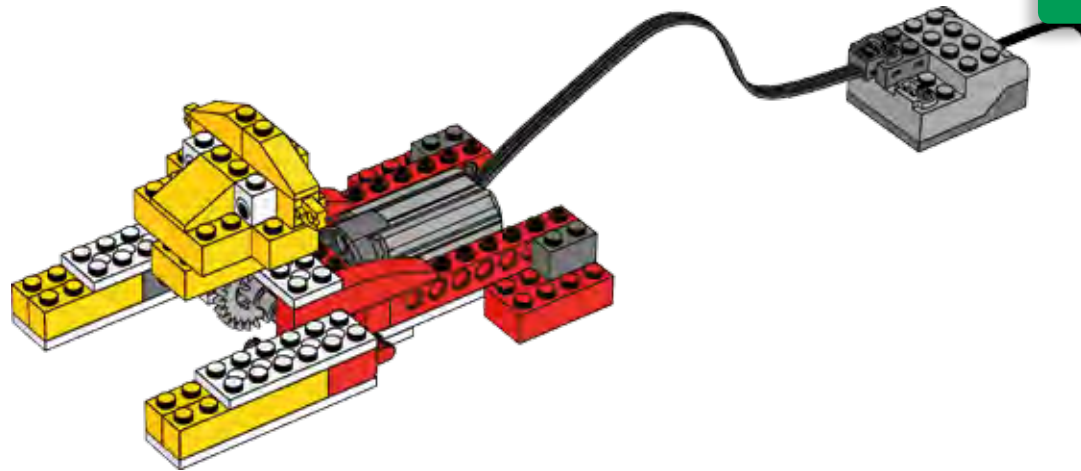

37

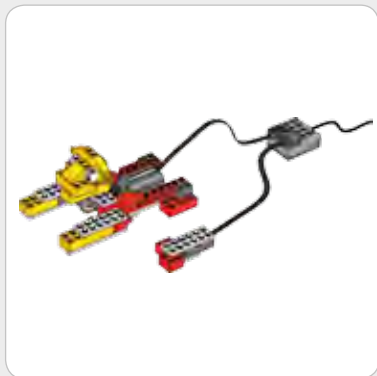

38

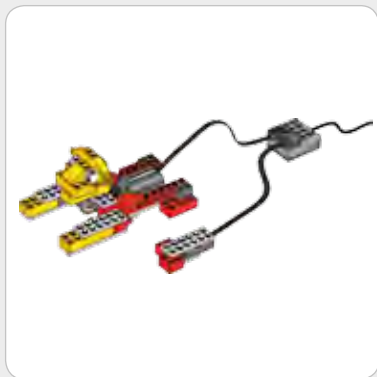

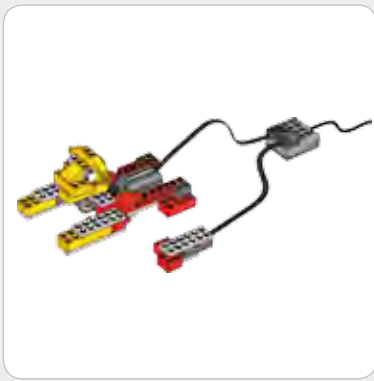

39

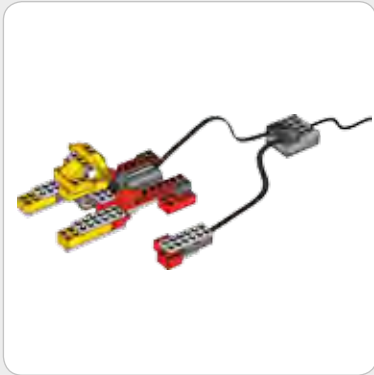
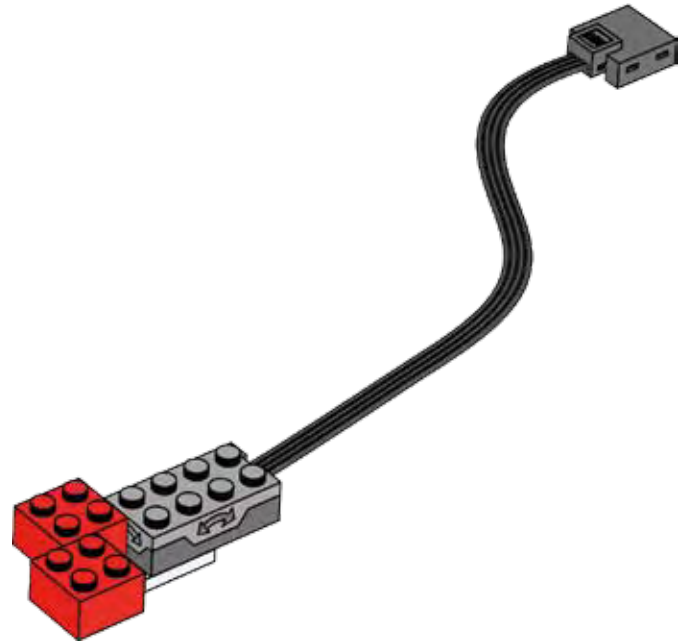

40

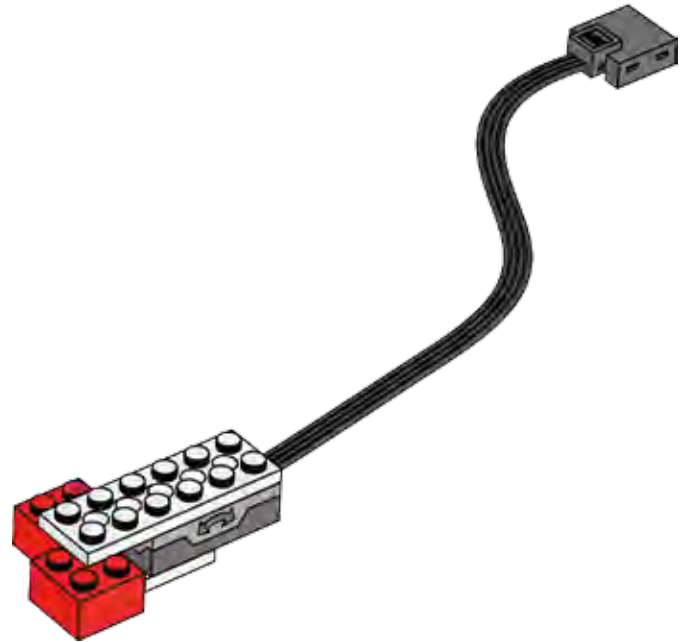

41

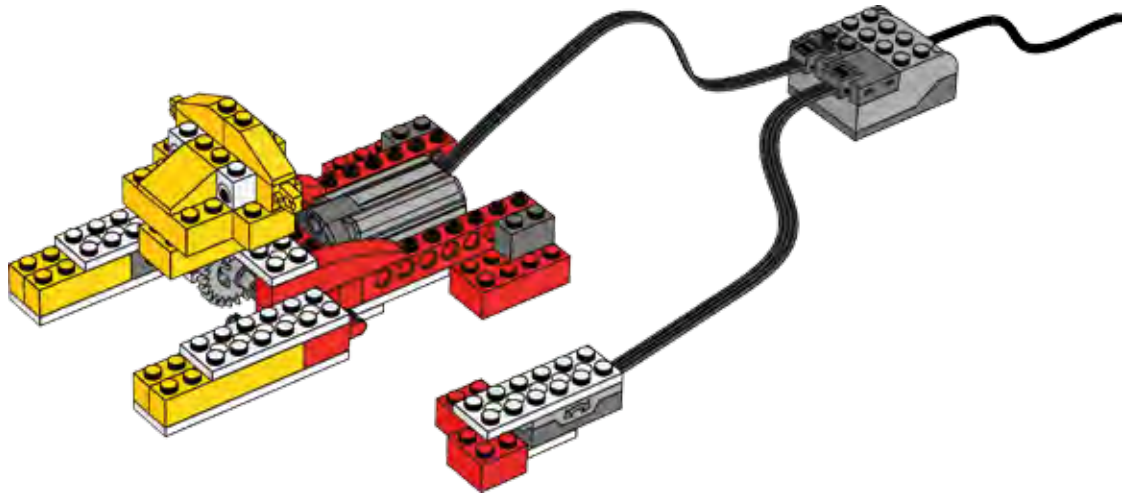
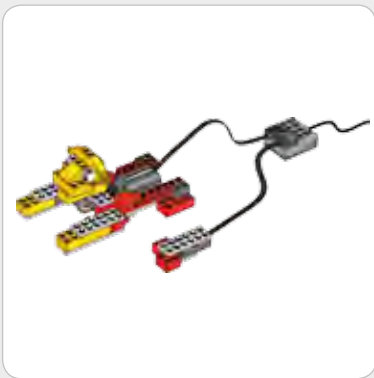

Programación Robot

1



2



3



4

